

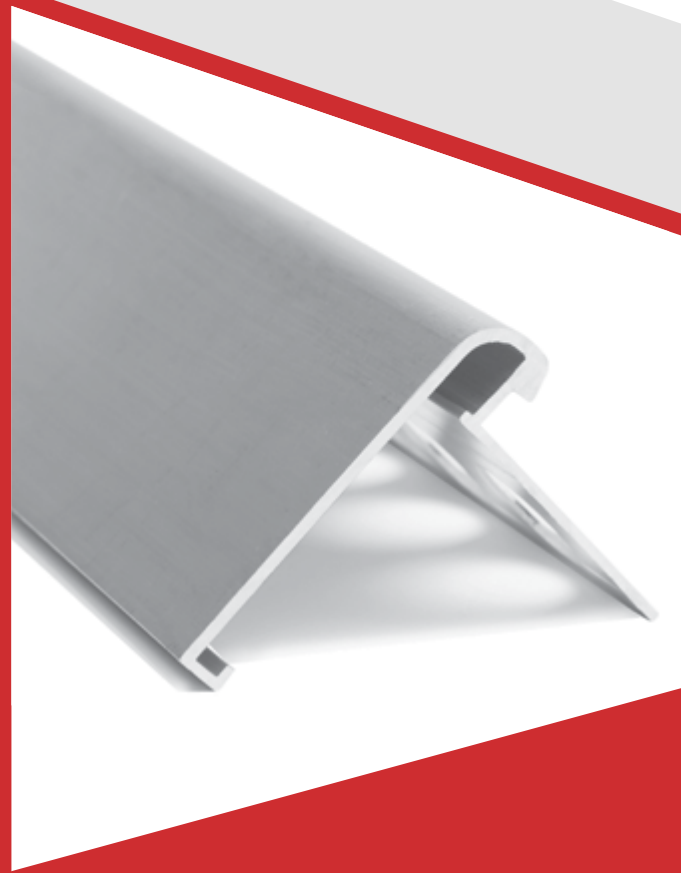

FLOORING TRIMS & TRANSITIONS CATALOG

NOVEMBER 2018

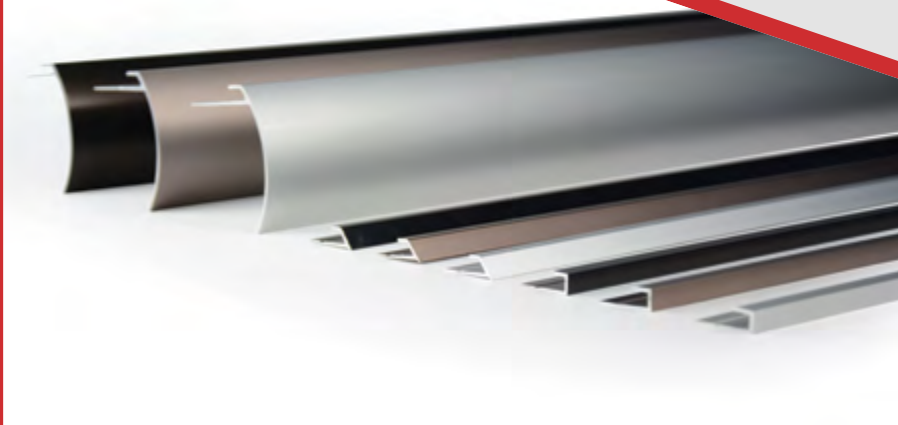

48 HOUR
GUARANTEE
OR IT'S FREE!*

WWW.POWERHOLD.COM

Why POWERHOLD Floor Covering Trims?

48 Hour guarantee*

Consistent lead times

Exceptional customer service

High quality premium finishes

85 years of reputable service levels

ISO 2008 certified / Lean manufacturer

99% customer retention for over 10 years

Market share leader in flooring transitions



***48 HOUR GUARANTEE**

Items listed with the 48 Hour Guarantee icon are guaranteed to ship in 48 hours or less from the time a purchase order is received and we ship the product. 48 Hour Guarantee does not apply if ordering more than your average number of pieces within the last 6 month period.



POWERHOLD HAS A BETTER WAY TO CAP OFF GREAT PRODUCTS

Our innovative end cap design makes accessing stored trim easy and intuitive. Color coding lets you know which finish has been applied to the trim. Our tube and cap design enables you to safely transfer metals from location to location.



PRODUCT PALLETIZING

To best protect the product during shipping, it is tubed, palletized and secured ensuring the quality of the delivered trim.

CONTENTS

▶ CATALOG INFORMATION

Product Information	2
Aluminum Finishes	7
New Products	8

▶ CARPET METAL TRIMS

½" Standard Pin Clampdown (CM 104, CM3703, CM 3703 Flex)	11
9/16" Standard Pin Clampdown (CM 95, CM 12-2114, CM 12-2117, CM 12-2118)	11
½" Premium Pin Clampdown (CM 102, CM 106 Flex)	12
9/16" Premium Pin Clampdown (CM 101, CM 105 Flex, CM 3705, CM 3705 Flex)	12
5/8" Premium Pin Clampdown (CM 100, CM 109 Flex)	12
11/16" Premium Pin Clampdown (CM 3704)	12
¾" Premium Pin Clampdown (CM 99A, CM 107A Flex)	13
¾" Deluxe Pin Clampdown (CM 99, CM 107 Flex, CM 654, CM 654 Flex)	13
1" Commercial Pin Clampdown (CM 103)	13
½" Premium Pinless Clampdown (CM 201, CM205 Flex)	14
9/16" Deluxe Pinless Clampdown (CM 211, CM 211 Flex)	14
11/16" Blank Clampdown for Tack Strips (CM 121)	15
Carpet Tile Joiner (CM 308)	15
1 ½" Joiner with Pins (CM 108)	15
1 12/32" Pinless Joiner (CM 208)	16
1 9/16" Joiner with Pins (CM 112)	16
1 ½" Pinless Joiner (CM 212)	16
1 3/8" Vinyl Insert Carpet Metal with Pins (CM 110, CM 110 Flex)	16
1 9/16" Vinyl Insert Carpet Metal with Pins (CM 3750)	17
1 3/8" Vinyl Insert Carpet Metal with Pins / Extender (CM 115)	17
1 3/8" Vinyl Insert Carpet Metal with Pins (Canadian) (CM 310, CM 310 Flex)	17
1 ¼" Vinyl Insert Pinless Carpet Metal (CM 210, CM 210 Flex)	17
1 ¼" Vinyl Insert Pinless / Extender (CM 215)	17
1 ¼" Vinyl Insert Pinless Trim (Canadian)(CM 410, CM 410 Flex)	18
1 ¼" Vinyl Single Flange Track (VT 253 White)	18

▶ Z-BAR, BINDER BARS & CARPET BAR

1" Standard Binder Bar (CM 313)	18
1" Deluxe Binder Bar (CM 303)	19
1 ½" Standard Binder Bar (CM 312)	19
1 ½" Premium Binder Bar (CM 302)	19
2" Deluxe Binder Bar (CM 304)	19
2 ½" Deluxe Binder Bar (CM 315, CM 305)	20
¾" Binder Bar - Overlap Edging (CM 701)	20
Z-Bar	20
¾" Seam Binder (CM 702)	21
1" Seam Binder (CM 705)	21
1 ¼" Seam Binder (CM 703)	21
2 ½" Seam Binder (CM 704)	21

▶ STAIR NOSING

7/64" 2.5mm LVT Stair Nosing (LVT 625)	22
1/8" 3mm LVT Stair Nosing (LVT 630)	22
5/32" 4mm LVT Stair Nosing (LVT 606)	22
3/16" 5mm LVT Stair Nosing (CM 608)	23
3/16" 5mm LVT Stair Nosing (CM 610)	23
15/64" 6mm LVT Stair Nosing (CM 604)	23
9/32" 7mm LVT Stair Nosing (LVT 612)	24
7/16" 8mm LVT Stair Nosing (CM 618)	24
1 1/16" Scribe-To Stair Nosing (CM 602)	24
1 1/16" Deluxe Stair Nosing (CM 601)	25
1 1/16" Standard Stair Nosing (CM 611)	25
1 5/8" Deluxe Stair Nosing (CM 605)	26
1 5/8" Standard Wide Tread Stair Nosing (CM 615)	26
1 7/8" Deluxe Stair Nosing (CM 627)	26
2" Standard Wide Tread Stair Nosing (CM 617)	27
2" Deluxe Stair Nosing (CM 607, CM 648)	27
2" Deluxe Stair Nosing (CM 637)	28
2 1/2" Commercial Stair Nosing (CM 603)	28
3 1/4" Commercial Stair Nosing (CM 609)	28
Drive Nails	29
Straight Edge	29

▶ COVING, SQUARE & BEVEL CAPS

7/64" 2.5mm Square Cap (CM 925)	30
1/8 3mm Square Cap (CM 906)	30
5/32" 4mm Square Cap (CM 904)	30
3/16" 5mm Square Cap (CM 905)	30
3/8" 7mm Square Cap (CM 907)	31
7/16" 8mm Square Cap (CM 908)	31
7/64" 2.5mm Bevel Cap (CM 425)	31
1/8" 3mm Bevel Cap (CM 406)	31
5/32" 4mm Bevel Cap (CM 404)	31
3/16" 5mm Bevel Cap (CM 405)	32
7/16" 7mm Bevel Cap (CM 407)	32
5/16" 8mm Bevel Cap (CM 408)	32
1/4" Round Coving Cap (CM 400)	32
3/32" Coving Cap (CM 903)	33
1/8" Coving Cap (CM 901)	33
1/4" Coving Cap (CM 401)	33

▶ LVT FLOORING TRIMS & TRANSITIONS

7/64" 2.5mm to 4.5mm LVT No-Lip Ramp (LVT 124)	35
1/8" 3mm to 4.5mm LVT No-Lip Ramp (LVT 125)	35
1/8" 3mm to 5mm LVT No-Lip Ramp (LVT 127)	35
1/8" 3mm LVT Reducer (LVT 113)	35

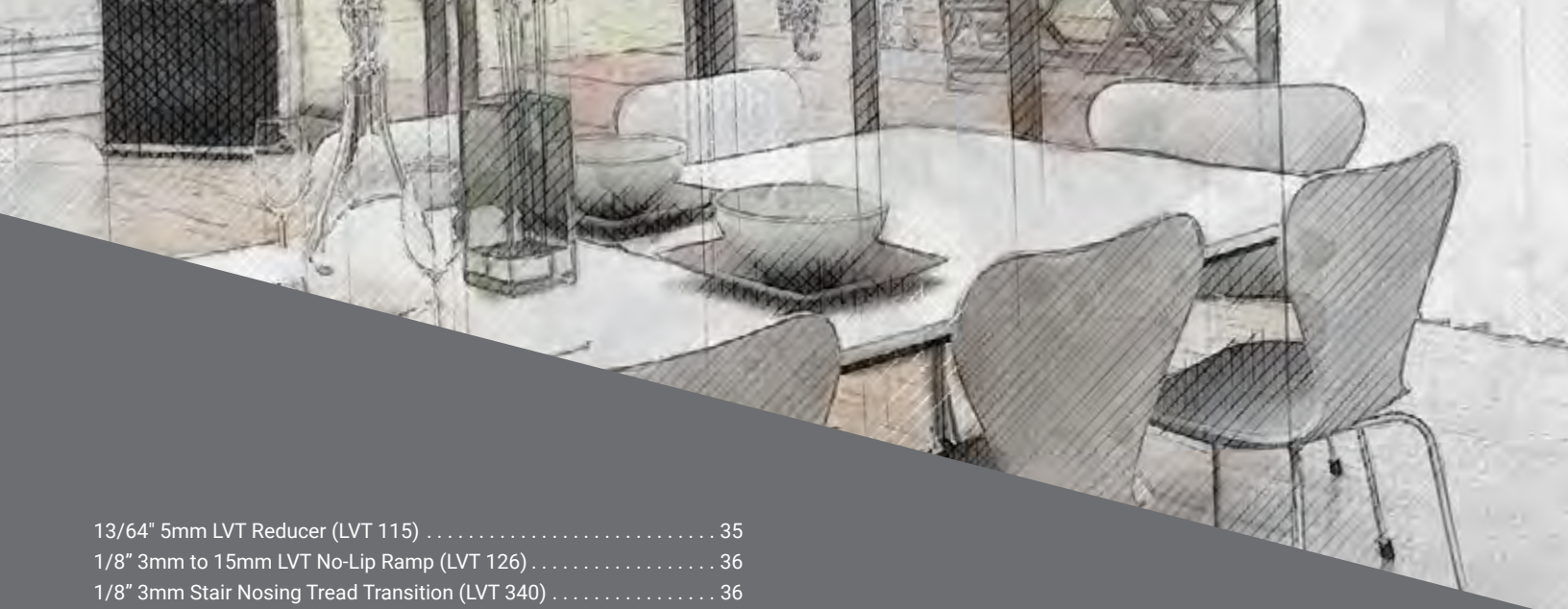

13/64" 5mm LVT Reducer (LVT 115)	35
1/8" 3mm to 15mm LVT No-Lip Ramp (LVT 126)	36
1/8" 3mm Stair Nosing Tread Transition (LVT 340)	36
13/64" 5mm Stair Nosing Tread Transition (LVT 341)	36
1/8" 3mm 80 degree Stair Nosing Tread Transition (LVT 342)	36
1/8" 3mm Stair Riser (LVT 330)	37
13/64" 5mm Stair Riser (LVT 331)	37
7/64" 2.5mm LVT Stair Nosing (LVT 625)	37
1/8" 3mm LVT Stair Nosing (LVT 630)	37
5/32" 4mm LVT Stair Nosing (LVT 606)	38
3/16" 5mm LVT Stair Nosing (LVT 608)	38
3/16" 5mm LVT Stair Nosing Long (LVT 610)	38
15/64" 6mm LVT Stair Nosing (LVT 604)	39
9/32" 7mm LVT Stair Nosing (LVT 612)	39
5/16" 8mm LVT Stair Nosing (LVT 618)	39
7/64" 2.5mm Bevel Cap (LVT 425)	40
1/8" 3mm Bevel Cap (LVT 406)	40
5/32" 4mm Bevel Cap (LVT 404)	40
3/16" 5mm Bevel Cap (LVT 405)	40
7/16" 7mm Bevel Cap (LVT 407)	41
5/16" 8mm Bevel Cap (LVT 408)	41
7/64" 2.5mm Square Cap (LVT 925)	42
1/8" 3mm Square Cap (LVT 906)	42
5/32" 4mm Square Cap (LVT 904)	42
3/16" 5mm Square Cap (LVT 905)	42
3/8" 7mm Square Cap (LVT 907)	43
5/16" 8mm Square Cap (LVT 908)	43
5/16" Ceramic Tile to LVT 3mm (LVT 230)	43
3/8" Ceramic Tile to LVT 3mm (LVT 235)	43
1/8" 3mm Carpet Tile to LVT (LVT 130)	44
3/16" 5mm Carpet to Tile LVT (LVT 150)	44
3/16" 5mm Carpet Tile to LVT/Bare Floor (LVT 160)	44
9/64" 2.5mm LVT Joiner (LVT 102)	44
1/8" 3mm LVT Joiner (LVT 103)	44
13/64" 5mm LVT Joiner (LVT 105)	44

► **CERAMIC FLOORING TRIMS**

1/4" EdgeTek L Shape (EdgeTek L 14)	47
1/4" Tile Trim (TT 14)	47
5/16" EdgeTek L Shape (EdgeTek L 516)	47
5/16" Tile Trim (TT 516)	47
3/8" EdgeTek L Shape (EdgeTek L 38)	48
3/8" Tile Trim (TT 38)	48
1/2" EdgeTek L Shape (EdgeTek L 12)	48
1/2" Tile Trim (TT 12)	48
5/8" Tile Trim (TT 58)	48
5/16" EdgeTek Tile Reducer (EdgeTek U 516)	49
3/8" EdgeTek Tile Reducer (EdgeTek U 38)	49
5/16" EdgeTek Tile Bullnose (EdgeTek R 516)	49
3/8" EdgeTek Tile Bullnose (EdgeTek R 38)	50
5/16" EdgeTek Tile to LVT (EdgeTek TLVT 516)	50
3/8" EdgeTek Tile to LVT (EdgeTek TLVT 38)	50
5/16" EdgeTek Carpet Tuck (EdgeTek CT 516)	51
3/8" EdgeTek Carpet Tuck (EdgeTek CT 38)	51
3/8" Ceramic Quarter Round (EdgeTek TQ 38)	51
5/16" Stair Nosing (EdgeTek TS 516)	52
3/8" Stair Nosing (EdgeTek TS 38)	52
3/8" Stair Nosing (EdgeTek SE 38)	52
7/8" Stair Nosing (EdgeTek SE 12)	52
3/8" EdgeTek Step (EdgeTek Step 38)	53
9/16" T-Seam Binder (EdgeTek T 916)	53
3/8" EdgeTek Square Corner (EdgeTek Q 38)	53

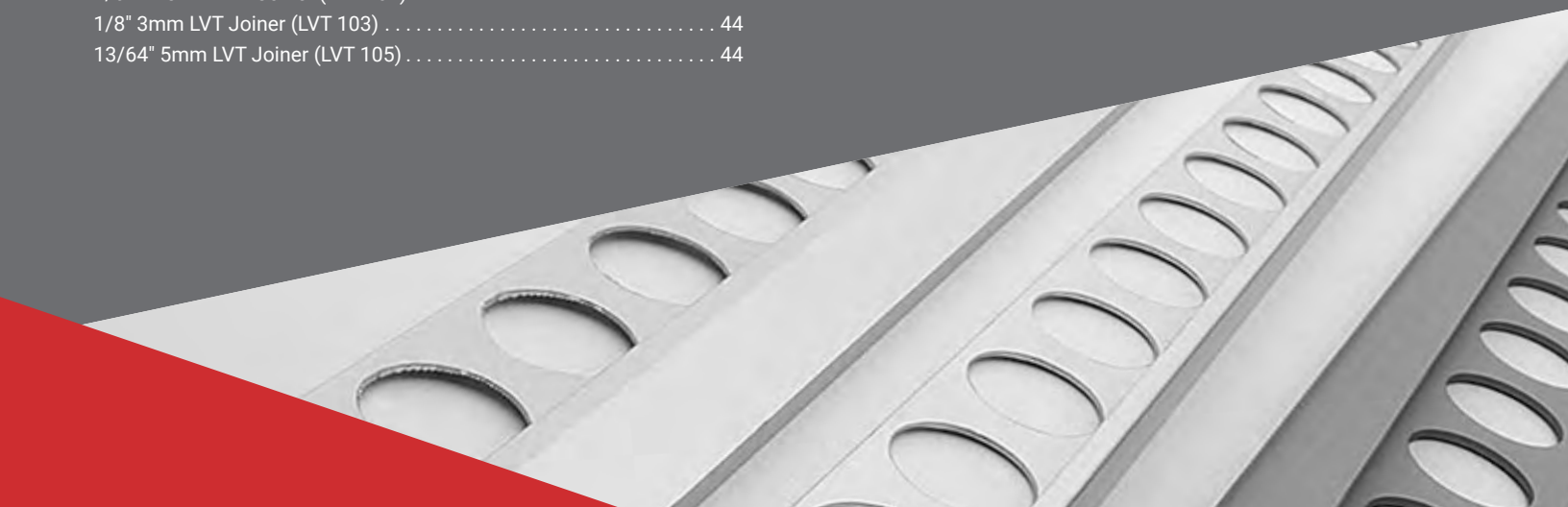

CONTENTS (Continued)

► SPECIALTY MOULDINGS

3/4" Tee Moulding (7365)	55
1" Tee Moulding (7395)	55
1/16" Cap (TM 80)	55
1/16" Flat Back Cap (TM 81)	55
1/16" Deep Slot Cap (TM 84)	56
3/32" Cap (TM 83)	56
3/32" Wide Face Cap (TM 82)	56
1/8" Cap (WB 104)	56
3/16" Cap (TM 72)	56
5/16" Cap (7358)	57
5/16" Wide Face Cap (7359)	57
13/32" Cap (7524)	57
1/16" Cap (TM 91)	57
1/16" Cove (TM 92, TM98, TM 90)	58
3/32" Cove (TM 85)	58
1/8" Cove (TM 87)	58
25/32" Offset Drill Cove (TM 52)	59
1/16" Divider (TM 94)	59
3/32" Divider (WB 110)	59
5/32" Divider (WB 103)	59
1/4" Division (WB 303)	60
1/16" Outside Corner (TM 93)	60
1/2" Plain Facing (TM 19)	60
3/4" Plain Facing (TM 21)	61
7/8" Plain Facing (TM 23)	61
1 1/16" Plain Facing (TM 25)	61
1 1/4" Plain Facing (TM 24)	61
1 1/4" Price Tag Conventional Moulding (0569)	61
13/16" Insert Oval Tee (0923)	62
13/16" Palisade Insert Tee (7364)	62
Panel Hanger (7389)	62
Slatwall Panel (7584)	63
1/2" x 1/8" Flatbar (1005)	63
3/4" x 1/8" Flatbar (1048)	63
1 x 1/8" Flatbar (1004)	64
1 1/4 x 1/8" Flatbar (1068)	64
1 1/2 x 1/8" Flatbar (1049)	64
1/2" Equal Angle (3141)	64
3/4" Equal Angle (0151)	65
1" Equal Angle (1061)	65
3/4" x 3/8" Angle (1750)	65

3/4" x 1/2" Angle (1225)	65
1" x 1/2" Angle (1033)	65
3/4" Equal Angle (1017)	66
1" Equal Angle (1018)	66
1 1/2" Equal Angle (1022)	66
2" Equal Angle (1137)	66
2 1/8" x 1" Angle (1249)	67
7/16" x 1/4" Channel (1347)	67
13/16" x 1/4" Channel (2223)	67
1/2" x 5/16" Channel (1038)	68
5/16" x 3/8" Channel (1285)	68
5/16" x 1/2" Channel (1362)	68
9/16" x 1/2" Channel (1346)	68
3/4" x 1/2" Channel (1538)	69
23/32" x 5/8" Channel (1345)	69
5/16" x 3/4" Channel (2161)	69
1/2" x 3/4" Channel (1040)	69
3/4" x 3/4" Channel (1710)	70
1" x 3/4" Channel (1041)	70
1" x 3/4" Top Channel (7347)	70

► VINYL TRIMS

Single Flange Track (VT 253)	73
1 1/4" Cove Stick (VT 051)	73
1 1/2" Cove Stick (VT 052)	73
Reducer For Glue-Down Carpet (VT 320, VT 333, VT 332, VT 331)	73
Tile Reducer For Resilient Floors (VT 324, VT 325)	74
Over The Top Resilient Reducer (VT 326)	74
Tile and Carpet Joiner (VT 754, VT 756)	74
Stair Nosing (VT 640, VT 642, VT 641, VT 644)	75
Snap-In Dividers and Edges (VT 704, VT 703, VT 706, VT 705)	76
Carpet Coving Cap (VT 410, VT 416)	77

► FUTURA TROWELS

Trowel Specs	79
Premium Trowels	80
Economy Trowels	82
Trowel Selector Guide	84



ALUMINUM FINISHES



MF

Mill Finish



EA/MFA

Etched Aluminum
Mill Finish Anodize



BBDA/POLALM

Buffed Bright Dip
Anodize
Polished Aluminum



EN

Etched Nickel



EBLK

Etched Black



BDB/BB

Bright Dip Brass
Bright Brass



EB/BB/MFB

Etched Brass
Mill Finish Brass



EBRZ

Etched Dark Bronze



BW-PVC

Bright White



SP-PVC

Sand Pebble



BA

Buffed Anodized



HEA/HMF

Hammered Etched
Anodize
Hammered Mill Finish



HN

Hammered Nickel



HBRZ

Hammered Bronze



HB

Hammered Brass



HBDB

Hammered Bright Dip
Brass



CVG

Coventry Gold



CHERRY



OAK



GUNSTOCK

NEW PRODUCTS

NEW LVT TRIMS & TRANSITIONS

REDUCERS

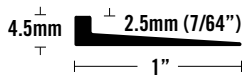

LVT 124 LVT Reducer
FINISH: MF
PAGE: 35



LVT 127 LVT Reducer
FINISH: MF
PAGE: 35

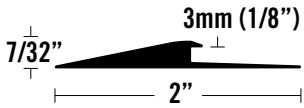

LVT 113 LVT Reducer
FINISH: EA, EN, EBRZ
PAGE: 35

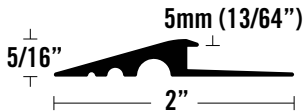

LVT 115 LVT Reducer
FINISH: EA, EN, EBRZ
PAGE: 35

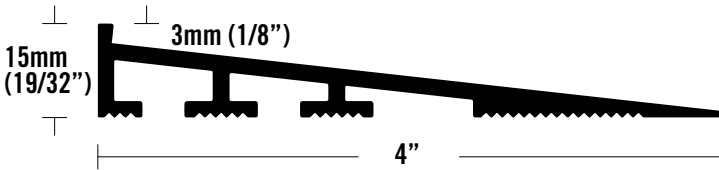

LVT 126 LVT Reducer
FINISH: MF
PAGE: 36

END CAPS

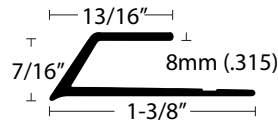

LVT 408 Bevel Cap
FINISH: EA, EN, EBRZ
PAGE: 41

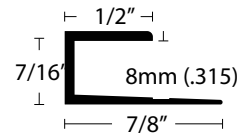

LVT 908 Square Cap
FINISH: EA, EN, EBRZ
PAGE: 43



NEW PRODUCTS

NEW LVT TRIMS & TRANSITIONS

JOINERS

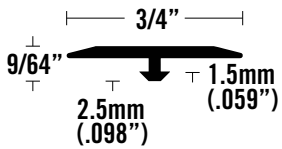

LVT 102 LVT Joiner

FINISH: EA, EN, EBRZ
PAGE: 45

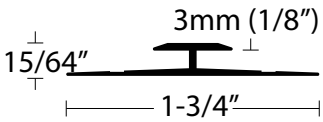

LVT 103 LVT Joiner

FINISH: EA, EN, EBRZ
PAGE: 45

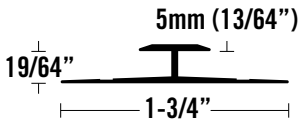

LVT 105 LVT Joiner

FINISH: EA, EN, EBRZ
PAGE: 45

STAIR SOLUTIONS

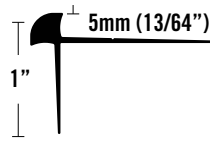

LVT 341 Nosing Tread Transition

FINISH: EA, EN, EBRZ
PAGE: 36

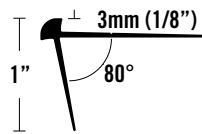

LVT 342 Nosing Tread Transition

FINISH: EA, EN, EBRZ
PAGE: 36

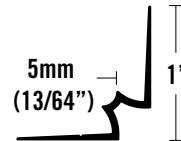

LVT 331 Stair Riser

FINISH: EA, EN, EBRZ
PAGE: 37

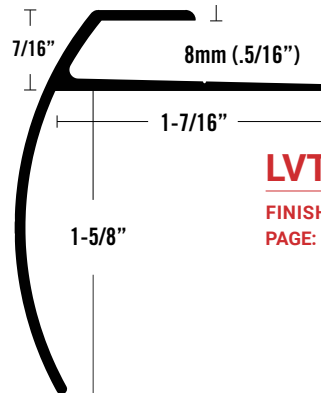

LVT 612 Stair Nosing

FINISH: EA, EN, EBRZ
PAGE: 39

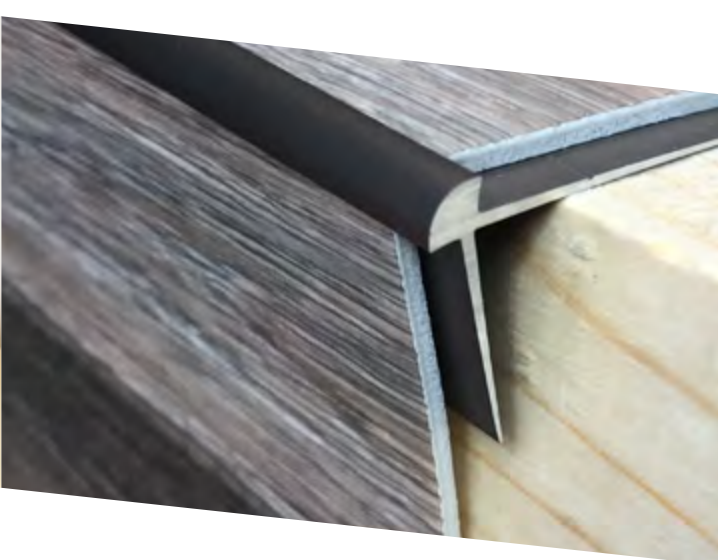

CARPET METAL TRIMS

Designer trims made to protect and enhance your flooring investment.





CLAMPDOWN WITH PINS

- Durable clampdown allows protection to carpet edge in areas of high traffic.
- Sharp pins provide strong, long lasting grip on carpets.

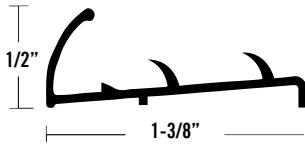

1/2" STANDARD PIN CLAMPDOWN

ITEM	ITEM DESCRIPTION	NAILS INCL.	LENGTH	QTY	WEIGHT
031638	CM 3703 HMF ⁴⁸	NO	12'	40	52
031646	CM 3703 HB ⁴⁸	NO	12'	40	52
031653	CM 3703 HEA	NO	12'	40	52
401200	CM 3703 HN	NO	12'	40	52
031745	CM 3703 HMF-FLEX	NO	12'	12	17
031752	CM 3703 HB-FLEX	NO	12'	12	17
406132	CM 3703 HN-FLEX	NO	12'	12	17

► Punched for nails on 6" centers

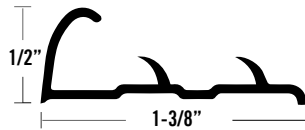

1/2" STANDARD PIN CLAMPDOWN

ITEM	ITEM DESCRIPTION	NAILS INCL.	LENGTH	QTY	WEIGHT
401127	CM 104 HMF ⁴⁸	NO	12'	40	53
401128	CM 104 HB ⁴⁸	NO	12'	40	53
401126	CM 104 HEA	NO	12'	40	53
401199	CM 104 HN ⁴⁸	NO	12'	40	53
390162	CM 104 HBRZ	NO	12'	24	34

► Punched for nails on 6" centers

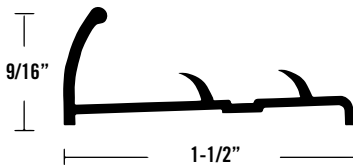

9/16" STANDARD PIN CLAMPDOWN

ITEM	ITEM DESCRIPTION	NAILS INCL.	LENGTH	QTY	WEIGHT
401060	CM 95 HMF ⁴⁸	NO	12'	40	61
401061	CM 95 HB ⁴⁸	NO	12'	40	61

► Punched for nails on 6" centers

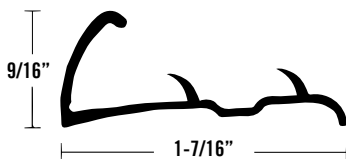

9/16" STANDARD PIN CLAMPDOWN

ITEM	ITEM DESCRIPTION	NAILS INCL.	LENGTH	QTY	WEIGHT
401147	CM 12-2114 HMF ⁴⁸	NO	12'	40	61
021217	CM 12-2114 HMF (CARTON) ⁴⁸	NO	12'	40	61
401148	CM 12-2117 HB ⁴⁸	NO	12'	40	61
021225	CM 12-2117 HB (CARTON) ⁴⁸	NO	12'	40	61
401201	CM 12-2118 HN	NO	12'	40	61
401149	CM 12-2114 HMF-FLEX	NO	12'	12	19
401155	CM 12-2117 HB-FLEX	NO	12'	12	19
401195	CM 12-2118 HN-FLEX	NO	12'	12	19

► Punched for nails on 6" centers

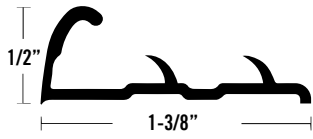

1/2" PREMIUM PIN CLAMPDOWN

ITEM	ITEM DESCRIPTION	NAILS INCL.	LENGTH	QTY	WEIGHT
401108	CM 102 HMF ⁴⁸	NO	12'	40	66
401109	CM 102 HB ⁴⁸	NO	12'	40	66
401202	CM 102 HN ⁴⁸	NO	12'	40	66
401145	CM 106 HMF-FLEX ⁴⁸	NO	12'	12	21
401146	CM 106 HB-FLEX ⁴⁸	NO	12'	12	21
401168	CM 106 HN-FLEX ⁴⁸	NO	12'	12	21

▶ Punched for nails on 6" centers

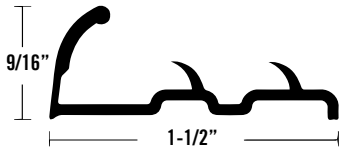

9/16" PREMIUM PIN CLAMPDOWN

ITEM	ITEM DESCRIPTION	NAILS INCL.	LENGTH	QTY	WEIGHT
401105	CM 101 HMF ⁴⁸	NO	12'	40	75
401106	CM 101 HB ⁴⁸	NO	12'	40	75
401203	CM 101 HN ⁴⁸	NO	12'	40	75
401132	CM 105 HMF-FLEX	NO	12'	12	24
401133	CM 105 HB-FLEX	NO	12'	12	24

▶ Punched for nails on 6" centers

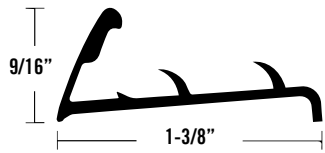

9/16" PREMIUM PIN CLAMPDOWN

ITEM	ITEM DESCRIPTION	NAILS INCL.	LENGTH	QTY	WEIGHT
031992	CM 3705 HMF ⁴⁸	NO	12'	40	69
032032	CM 3705 HB ⁴⁸	NO	12'	40	69

▶ Punched for nails on 6" centers

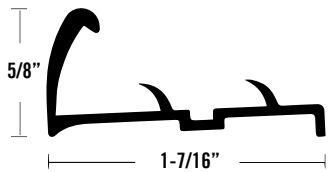

5/8" PREMIUM PIN CLAMPDOWN

ITEM	ITEM DESCRIPTION	NAILS INCL.	LENGTH	QTY	WEIGHT
401083	CM 100 HMF ⁴⁸	NO	12'	40	80
401084	CM 100 HB ⁴⁸	NO	12'	40	80
401080	CM 109 HMF-FLEX	NO	12'	12	27
401081	CM 109 HB-FLEX	NO	12'	12	27

▶ Punched for nails on 6" centers

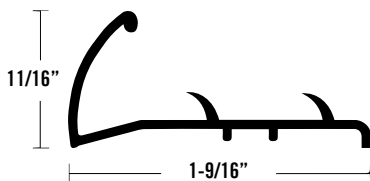

11/16" PREMIUM PIN CLAMPDOWN

ITEM	ITEM DESCRIPTION	NAILS INCL.	LENGTH	QTY	WEIGHT
031104	CM 3704 HMF ⁴⁸	NO	12'	40	69
031161	CM 3704 HB ⁴⁸	NO	12'	40	69
401204	CM 3704 HN ⁴⁸	NO	12'	40	69
031179	CM 3704 HBDB ⁴⁸	NO	12'	40	69

▶ Punched for nails on 6" centers

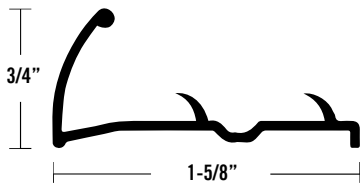

3/4" PREMIUM PIN CLAMPDOWN

ITEM	ITEM DESCRIPTION	NAILS INCL.	LENGTH	QTY	WEIGHT
401070	CM 99A HMF ⁴⁸	NO	12'	40	71
401071	CM 99A HB ⁴⁸	NO	12'	40	71
401205	CM 99A HN	NO	12'	40	71
401087	CM 99A HBDB	NO	12'	40	71
401086	CM 99A CVG	NO	12'	24	44
390166	CM 99A HBRZ	NO	12'	24	44
401107	CM 99A OAK	NO	12'	24	44
401116	CM 99A CHERRY	NO	12'	24	44
401117	CM 99A GUNSTOCK	NO	12'	24	44
401052	CM 107A HMF-FLEX	NO	12'	12	22
401053	CM 107A HB-FLEX	NO	12'	12	22
401057	CM 107A HN-FLEX	NO	12'	12	22
401059	CM 107A HBRZ-FLEX	NO	12'	12	22

► Punched for nails on 6" centers

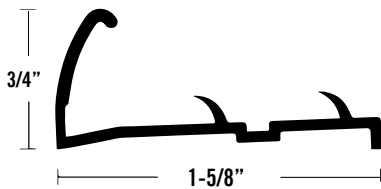

3/4" DELUXE PIN CLAMPDOWN

ITEM	ITEM DESCRIPTION	NAILS INCL.	LENGTH	QTY	WEIGHT
401074	CM 99 HMF ⁴⁸	NO	12'	40	89
401075	CM 99 HB ⁴⁸	NO	12'	40	89
401093	CM 99 HBDB	NO	12'	12	29
401077	CM 107 HMF-FLEX	NO	12'	12	27
401078	CM 107 HB-FLEX	NO	12'	12	27
401094	CM 107 HBDB-FLEX	NO	12'	12	27

► Punched for nails on 6" centers

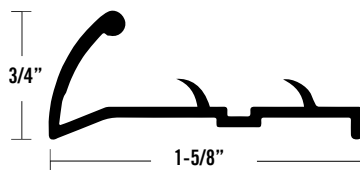

3/4" DELUXE PIN CLAMPDOWN

ITEM	ITEM DESCRIPTION	NAILS INCL.	LENGTH	QTY	WEIGHT
409920	CM 654 HMF ⁴⁸	NO	12'	40	89
409925	CM 654 HMF	NO	12'	24	55
409921	CM 654 HB ⁴⁸	NO	12'	40	89
409926	CM 654 HB	NO	12'	24	55
401206	CM 654 HN ⁴⁸	NO	12'	40	89
409923	CM 654 HBDB	NO	12'	40	89
409927	CM 654 HBDB	NO	12'	24	55
401098	CM 654 HMF-FLEX	NO	12'	12	26
401099	CM 654 HN-FLEX	NO	12'	12	26

► Punched for nails on 6" centers

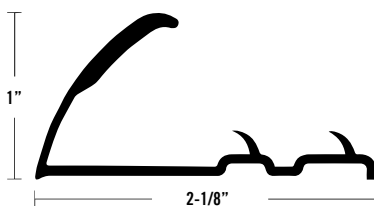

1" COMMERCIAL PIN CLAMPDOWN

ITEM	ITEM DESCRIPTION	NAILS INCL.	LENGTH	QTY	WEIGHT
401118	CM 103 HMF	NO	12'	12	44
401119	CM 103 HB	NO	12'	12	44

► Punched for nails on 6" centers

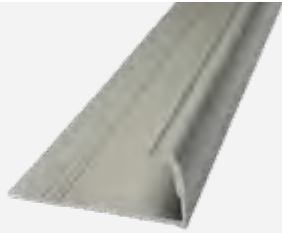

PINLESS CLAMPDOWNS

- Pinless material made for glue down carpets.

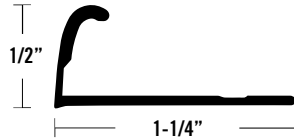

1/2" PREMIUM PINLESS CLAMPDOWN

ITEM	ITEM DESCRIPTION	NAILS INCL.	LENGTH	QTY	WEIGHT
402106	CM 201 HMF ⁴⁸	NO	12'	40	52
402123	CM 201 HMF	NO	12'	24	33
402108	CM 201 HB ⁴⁸	NO	12'	40	52
402115	CM 201 HB	NO	12'	24	33
402109	CM 201 HEA	NO	12'	40	52
401207	CM 201 HN ⁴⁸	NO	12'	40	52
402116	CM 201 HBDB	NO	12'	24	33
402105	CM 201 CVG	NO	12'	24	33
390167	CM 201 HBRZ	NO	12'	24	33
401325	CM 205 HMF-FLEX	NO	12'	12	16
401326	CM 205 HB -FLEX	NO	12'	12	16
401104	CM 205 HEA-FLEX	NO	12'	12	16
402122	CM 205 HN-FLEX	NO	12'	12	16

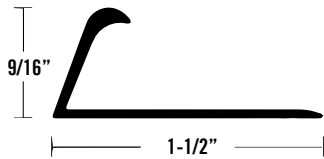

9/16" DELUXE PINLESS CLAMPDOWN

ITEM	ITEM DESCRIPTION	NAILS INCL.	LENGTH	QTY	WEIGHT
402150	CM 211 HMF	NO	12'	40	61
402153	CM 211 HMF	NO	12'	12	20
402151	CM 211 HB	NO	12'	40	61
401352	CM 211 HB	NO	12'	12	20
402149	CM 211 HMF-FLEX	NO	12'	12	18

► No fabrication, nail starter lines



BLANK CLAMPDOWN FOR TACK STRIP

- Blank bar allows for a tack strip to be glued down on top of metal.
- Durable clampdown allows protection to carpet edge in areas of high traffic.

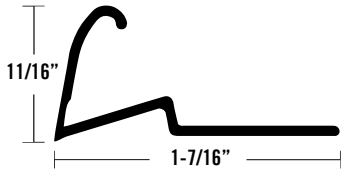

1 1/16" CLAMPDOWN FOR TACK STRIPS

ITEM	ITEM DESCRIPTION	NAILS INCL.	LENGTH	QTY	WEIGHT
401252	CM 121 HMF ⁴⁸	NO	12'	40	69
401253	CM 121 HB ⁴⁸	NO	12'	40	69
401208	CM 121 HN	NO	12'	40	69



JOINER BARS

- Joiner bar divides glued or stretched-in carpets to ceramic, laminate, or hardwood floors.

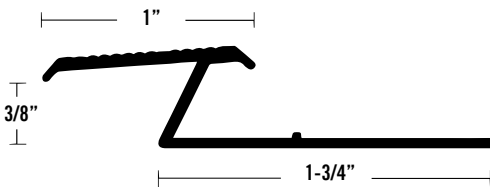

CARPET TILE JOINER

ITEM	ITEM DESCRIPTION	NAILS INCL.	LENGTH	QTY	WEIGHT
403157	CM 308 MFA	NO	12'	12	35
403158	CM 308 MFB	NO	12'	12	35
403228	CM 308 EN	NO	12'	12	35

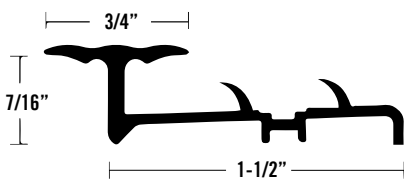

1 1/2" JOINER WITH PINS

ITEM	ITEM DESCRIPTION	NAILS INCL.	LENGTH	QTY	WEIGHT
401150	CM 108 HMF	NO	12'	12	33
401151	CM 108 HB	NO	12'	12	33
401154	CM 108 HEA	NO	12'	12	33
401169	CM 108 HN	NO	12'	12	33

► Punched for nails on 6" centers

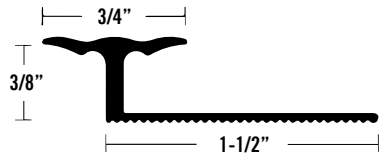

1 13/32" PINLESS JOINER

ITEM	ITEM DESCRIPTION	NAILS INCL.	LENGTH	QTY	WEIGHT
402135	CM 208 HMF	NO	12'	12	26
402136	CM 208 HB	NO	12'	12	26
402137	CM 208 HEA	NO	12'	12	26
401170	CM 208 HN	NO	12'	12	26

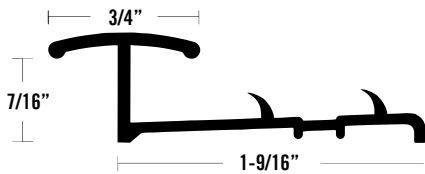

1 9/16" JOINER WITH PINS

ITEM	ITEM DESCRIPTION	NAILS INCL.	LENGTH	QTY	WEIGHT
401185	CM 112 HMF	NO	12'	12	32
401184	CM 112 HB	NO	12'	12	32
406134	CM 112 HEA	NO	12'	12	32
401186	CM 112 HN	NO	12'	12	32

► Punched for nails on 6" centers

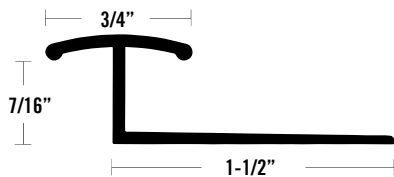

1 1/2" PINLESS JOINER

ITEM	ITEM DESCRIPTION	NAILS INCL.	LENGTH	QTY	WEIGHT
406133	CM 212 HEA	NO	12'	12	28
401189	CM 212 HN	NO	12'	12	28



INSERT METAL WITH PINS

- Allows for transition between action backed carpet and other flooring types.
- For use with vinyl insert.

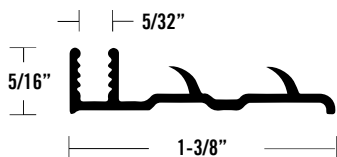

1 3/8" VINYL INSERT CARPET METAL WITH PINS

ITEM	ITEM DESCRIPTION	NAILS INCL.	LENGTH	QTY	WEIGHT
401159	CM 110 MF 	NO	12'	40	54
401165	CM 110 MF 	NO	12'	20	29
401160	CM 110 MF-FLEX 	NO	12'	12	16

► Punched for nails on 6" centers

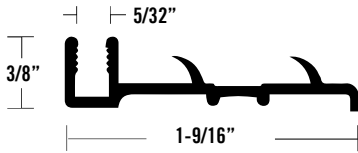

1 9/16" VINYL INSERT CARPET METAL WITH PINS

ITEM	ITEM DESCRIPTION	NAILS INCL.	LENGTH	QTY	WEIGHT
032552	CM 3750 MF	NO	12'	20	34

▶ Punched for nails on 6" centers

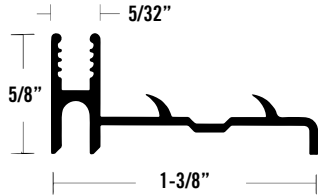

1 3/8" VINYL INSERT CARPET METAL WITH PINS/EXTENDER

ITEM	ITEM DESCRIPTION	NAILS INCL.	LENGTH	QTY	WEIGHT
415159	CM 115 MF	NO	12'	12	25

▶ Punched for nails on 6" centers

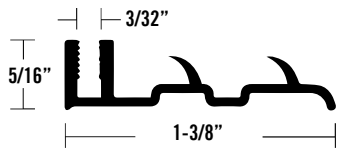

1 3/8" VINYL INSERT CARPET METAL WITH PINS

ITEM	ITEM DESCRIPTION	NAILS INCL.	LENGTH	QTY	WEIGHT
402160	CM 310 MF	NO	12'	40	65
402159	CM 310 MF-FLEX *	NO	12'	12	19

CANADIAN

▶ Canadian Vinyl Insert metal. Punched for Nails, 6" centers

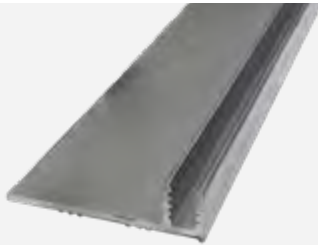

INSERT METAL PINLESS

- Allows for transition between non action backed carpet and other flooring types.
- For use with vinyl insert.

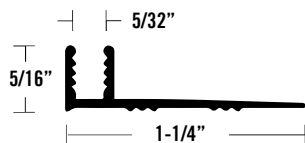

1 1/4" VINYL INSERT PINLESS CARPET METAL

ITEM	ITEM DESCRIPTION	NAILS INCL.	LENGTH	QTY	WEIGHT
401158	CM 210 MF	NO	12'	40	49
401166	CM 210 MF	NO	12'	20	26
401157	CM 210 MF-FLEX	NO	12'	12	15

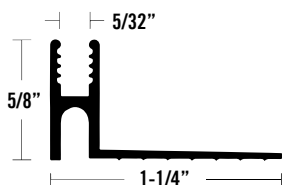

1 1/4" VINYL INSERT PINLESS / EXTENDER

ITEM	ITEM DESCRIPTION	NAILS INCL.	LENGTH	QTY	WEIGHT
415160	CM 215 MF	NO	12'	12	23

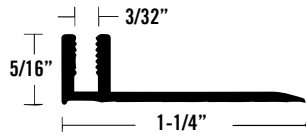

CANADIAN

1 1/4" VINYL INSERT PINLESS CARPET METAL

ITEM	ITEM DESCRIPTION	NAILS INCL.	LENGTH	QTY	WEIGHT
402161	CM 410 MF 	NO	12'	40	59
402163	CM 410 MF-FLEX	NO	12'	12	17

▶ Canadian Vinyl Insert metal



VINYL SINGLE FLANGE TRACK

ITEM	ITEM DESCRIPTION	LENGTH	QTY	WEIGHT
460530	VT 253 WHITE	12'	20	20







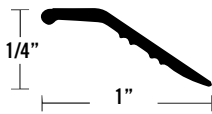

FLAT BAR

- Flat bar transitions between two surfaces of different height.



1" STANDARD BINDER BAR

ITEM	ITEM DESCRIPTION	NAILS INCL.	LENGTH	QTY	WEIGHT
403170	CM 313 HMF 	NO	12'	40	34
403181	CM 313 HMF 	YES	12'	40	37
403268	CM 313 HMF	YES	12'	24	24
403219	CM 313 HMF 	YES	12'	12	14
403171	CM 313 HB 	NO	12'	40	34
403180	CM 313 HB 	YES	12'	40	37
402119	CM 313 HB	YES	12'	24	24
403211	CM 313 HB 	YES	12'	12	14
403169	CM 313 HEA	NO	12'	40	34
404107	CM 313 HN	YES	12'	12	14
401209	CM 313 HN 	YES	12'	40	37
402132	CM 313 HBDB	YES	12'	24	24
403212	CM 313 HBDB	YES	12'	12	14
390437	CM 313 CVG	YES	12'	24	24
390165	CM 313 HBRZ	YES	12'	24	24

▶ Drilled and countersunk, 6" centers for #3 fastener

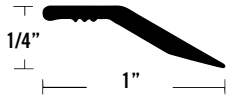

1" DELUXE BINDER BAR

ITEM	ITEM DESCRIPTION	NAILS INCL.	LENGTH	QTY	WEIGHT
403121	CM 303 HMF ⁴⁸	NO	12'	40	45
403122	CM 303 HB ⁴⁸	NO	12'	40	45
401210	CM 303 HN ⁴⁸	YES	12'	40	48

▶ Drilled and countersunk, 6" centers for #3 fastener



1 1/2" STANDARD BINDER BAR

ITEM	ITEM DESCRIPTION	NAILS INCL.	LENGTH	QTY	WEIGHT
403160	CM 312 HMF ⁴⁸	NO	12'	40	56
390432	CM 312 HMF ⁴⁸	YES	12'	40	58
390456	CM 312 HMF	YES	12'	24	36
403161	CM 312 HB ⁴⁸	NO	12'	40	56
390431	CM 312 HB ⁴⁸	YES	12'	40	58
390455	CM 312 HB	YES	12'	24	36
403159	CM 312 HEA	NO	12'	40	56
401211	CM 312 HN ⁴⁸	YES	12'	40	58
390435	CM 312 HBDB ⁴⁸	YES	12'	40	58
402129	CM 312 HBDB	YES	12'	24	36
390436	CM 312 CVG ⁴⁸	YES	12'	24	36
390163	CM 312 HBRZ	YES	12'	24	36
403257	CM 312 OAK	YES	12'	24	36
403258	CM 312 CHERRY	YES	12'	24	36
403259	CM 312 GUNSTOCK	YES	12'	24	36

▶ Drilled and countersunk, 6" centers for #3 fastener

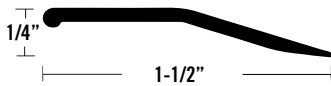

1 1/2" PREMIUM BINDER BAR

ITEM	ITEM DESCRIPTION	NAILS INCL.	LENGTH	QTY	WEIGHT
403111	CM 302 HMF ⁴⁸	NO	12'	40	59
403117	CM 302 HMF	YES	12'	40	61
403112	CM 302 HB ⁴⁸	NO	12'	40	59
403116	CM 302 HB	YES	12'	40	61
401212	CM 302 HN ⁴⁸	YES	12'	40	61
403118	CM 302 HBDB	YES	12'	40	61

▶ Drilled and countersunk, 6" centers for #3 fastener

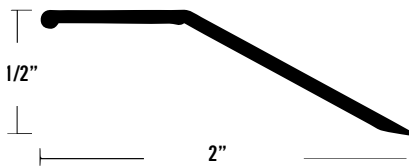

2" DELUXE BINDER BAR

ITEM	ITEM DESCRIPTION	NAILS INCL.	LENGTH	QTY	WEIGHT
403140	CM 304 HMF ⁴⁸	NO	12'	12	35
403182	CM 304 HMF ⁴⁸	YES	12'	12	35
403141	CM 304 HB ⁴⁸	NO	12'	12	35
403183	CM 304 HB ⁴⁸	YES	12'	12	35
401102	CM 304 HEA	NO	12'	12	35
403231	CM 304 HN	YES	12'	12	35
403142	CM 304 HBDB	YES	12'	12	35

▶ Drilled and countersunk, 6" centers for #3 fastener

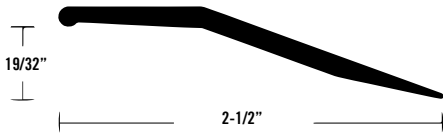

2 1/2" DELUXE BINDER BAR

ITEM	ITEM DESCRIPTION	NAILS INCL.	LENGTH	QTY	WEIGHT
403305	CM 315 HMF	YES	12'	12	54
403306	CM 315 HB	NO	12'	12	54

▶ Drilled and countersunk, 6" centers for #3 fastener

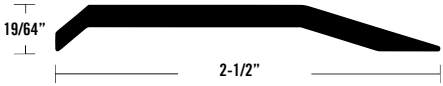

2 1/2" DELUXE BINDER BAR

ITEM	ITEM DESCRIPTION	NAILS INCL.	LENGTH	QTY	WEIGHT
390321	CM 305 HMF	NO	12'	12	62
390322	CM 305 HB	NO	12'	12	62

▶ Drilled and countersunk, 6" centers for #8 fastener

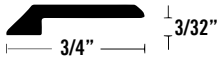

3/4" BINDER BAR-OVERLAPPING

ITEM	ITEM DESCRIPTION	NAILS INCL.	LENGTH	QTY	WEIGHT
407101	CM 701 HMF	NO	12'	40	34
403205	CM 701 HMF	YES	12'	40	37
403216	CM 701 HMF	YES	12'	12	14
407102	CM 701 HB	NO	12'	40	34
403206	CM 701 HB	YES	12'	40	37
401351	CM 701 HB	YES	12'	12	14
403136	CM 701 HEA	NO	12'	12	13

▶ Drilled and countersunk, 6" centers for #3 fastener



Z BAR

- Creates a finished edge for stretch-in carpet to hard flooring transitions.

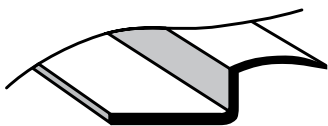

Z - BAR

ITEM	ITEM DESCRIPTION	NAILS INCL.	LENGTH	QTY	WEIGHT
404150	CM 501 MF	NO	4.0	25	5

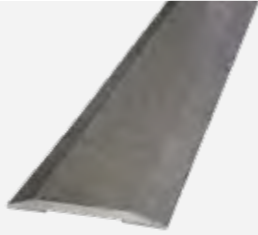

SEAM BINDER

- Seam binder transitions between two surfaces with large gap or equal height.

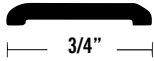

3/4" SEAM BINDER

ITEM	ITEM DESCRIPTION	NAILS INCL.	LENGTH	QTY	WEIGHT
407115	CM 702 HMF	NO	12'	40	39
403201	CM 702 HMF	YES	12'	40	42
407120	CM 702 HB	NO	12'	40	39
403202	CM 702 HB	YES	12'	40	42
407121	CM 702 HEA	NO	12'	40	39
401215	CM 702 HN	YES	12'	40	42

▶ Drilled and countersunk, 6" centers for #3 fastener

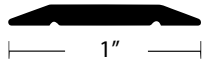

1" SEAM BINDER

ITEM	ITEM DESCRIPTION	NAILS INCL.	LENGTH	QTY	WEIGHT
401193	CM 705 HEA	NO	12'	40	52
401192	CM 705 HB	NO	12'	40	52
401216	CM 705 HN	NO	12'	40	52

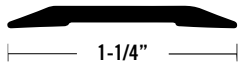

1 1/4" SEAM BINDER

ITEM	ITEM DESCRIPTION	NAILS INCL.	LENGTH	QTY	WEIGHT
407135	CM 703 HMF	NO	12'	40	57
403203	CM 703 HMF	YES	12'	40	59
407140	CM 703 HB	NO	12'	40	57
403204	CM 703 HB	YES	12'	40	59
401103	CM 703 HEA	NO	12'	40	57
401217	CM 703 HN	YES	12'	40	59

▶ Drilled and countersunk, 6" centers for #3 fastener

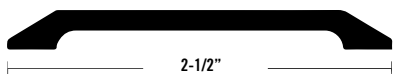

2 1/2" SEAM BINDER

ITEM	ITEM DESCRIPTION	NAILS INCL.	LENGTH	QTY	WEIGHT
031018	CM 704 HMF	YES	12'	12	63
570048	CM 704 MFA	NO	12'	12	63
031042	CM 704 HB	YES	12'	12	63

▶ Drilled and countersunk, 6" centers for #8 fastener

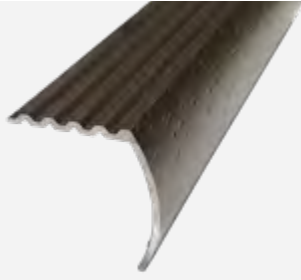

STAIR NOSING

- The durable stair nosing protects the edge of the stair from damage.
- Multiple drops and landing sizes available.

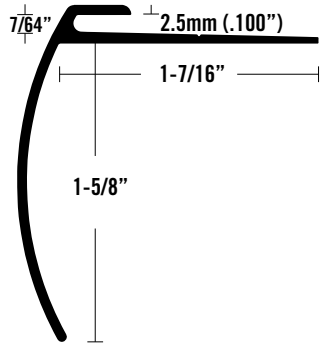

7/64" (2.5MM) LVT STAIR NOSING

ITEM	ITEM DESCRIPTION	NAILS INCL.	LENGTH	QTY	WEIGHT
402037	LVT 625 EA	NO	12'	12	36
402038	LVT 625 EN	NO	12'	12	36
402039	LVT 625 EBRZ	NO	12'	12	36

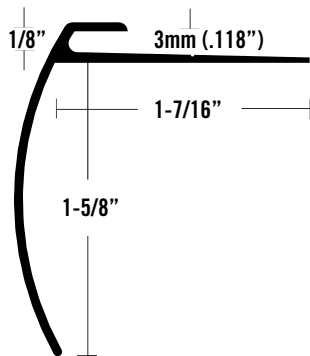

1/8" (3MM) LVT STAIR NOSING

ITEM	ITEM DESCRIPTION	NAILS INCL.	LENGTH	QTY	WEIGHT
402040	LVT 630 EA	NO	12'	12	37
402041	LVT 630 EN	NO	12'	12	37
402042	LVT 630 EBRZ	NO	12'	12	37

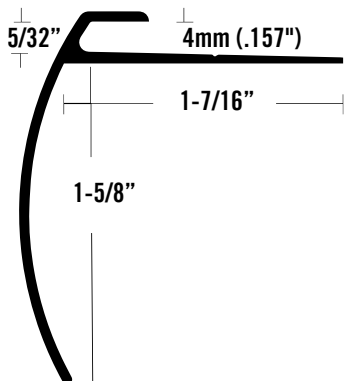

5/32" (4MM) LVT STAIR NOSE

ITEM	ITEM DESCRIPTION	NAILS INCL.	LENGTH	QTY	WEIGHT
401176	LVT 606 EA	NO	12'	12	37
401177	LVT 606 EN	NO	12'	12	37
401175	LVT 606 BRZ	NO	12'	12	37

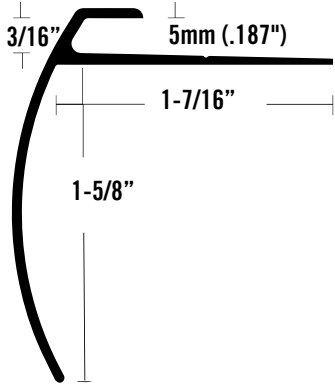

3/16" (5MM) LVT STAIR NOSE

ITEM	ITEM DESCRIPTION	NAILS INCL.	LENGTH	QTY	WEIGHT
389141	LVT 608 EA	NO	12'	12	37
389143	LVT 608 EN	NO	12'	12	37
390168	LVT 608 BRZ	NO	12'	12	37
389142	LVT 608 EB	NO	12'	12	37

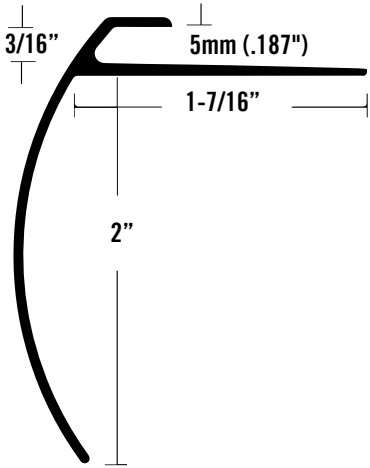

3/16" (5MM) LVT STAIR NOSING

ITEM	ITEM DESCRIPTION	NAILS INCL.	LENGTH	QTY	WEIGHT
401178	LVT 610 EA	NO	12'	12	41
401179	LVT 610 EN	NO	12'	12	41
401180	LVT 610 BRZ	NO	12'	12	41

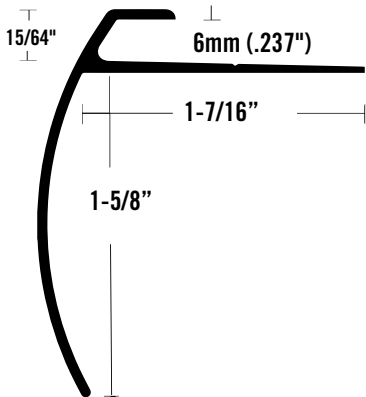

15/64" (6MM) LVT STAIR NOSING

ITEM	ITEM DESCRIPTION	NAILS INCL.	LENGTH	QTY	WEIGHT
401197	LVT 604 EA	NO	12'	12	37
401198	LVT 604 EN	NO	12'	12	37
401196	LVT 604 BRZ	NO	12'	12	37

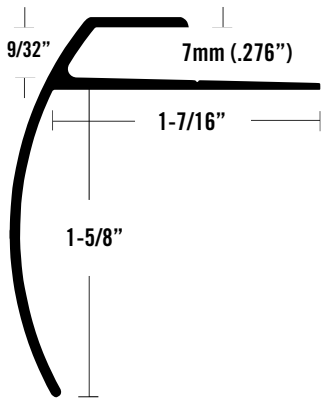

9/32" (7MM) LVT STAIR NOSING

ITEM	ITEM DESCRIPTION	NAILS INCL.	LENGTH	QTY	WEIGHT
402043	LVT 612 EA	NO	12'	12	40
402044	LVT 612 EN	NO	12'	12	40
402045	LVT 612 EBRZ	NO	12'	12	40

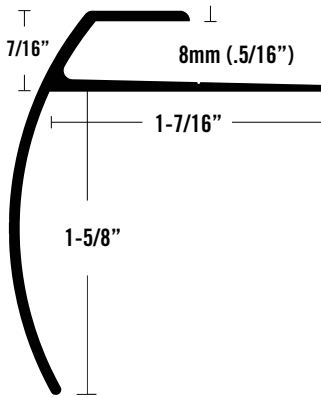

5/16" (8MM) LVT STAIR NOSING

ITEM	ITEM DESCRIPTION	NAILS INCL.	LENGTH	QTY	WEIGHT
402059	LVT 618 EA	NO	12'	12	40
402060	LVT 618 EN	NO	12'	12	40
402061	LVT 618 EBRZ	NO	12'	12	40

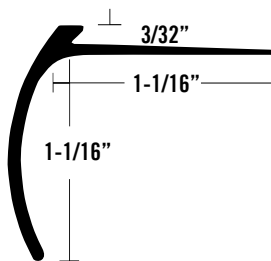

1 1/16" "SCRIBE-TO" STAIR NOSING

ITEM	ITEM DESCRIPTION	NAILS INCL.	LENGTH	QTY	WEIGHT
406121	CM 602 HMF	NO	12'	40	81
406122	CM 602 HB	NO	12'	40	81

► Drilled and countersunk, 6" centers for #3 fastener

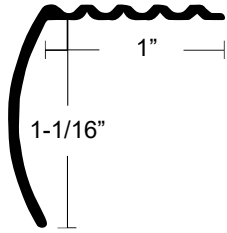

1" STANDARD STAIR NOSING

ITEM	ITEM DESCRIPTION	NAILS INCL.	LENGTH	QTY	WEIGHT
406115	CM 611 HMF ⁴⁸	NO	12'	40	68
403207	CM 611 HMF ⁴⁸	YES	12'	40	70
403267	CM 611 HMF	YES	12'	24	43
403218	CM 611 HMF ⁴⁸	YES	12'	12	23
406116	CM 611 HB ⁴⁸	NO	12'	40	68
403187	CM 611 HB ⁴⁸	YES	12'	40	70
402124	CM 611 HB	YES	12'	24	43
403214	CM 611 HB ⁴⁸	YES	12'	12	23
403230	CM 611 HEA	YES	12'	40	70
401213	CM 611 HN ⁴⁸	YES	12'	40	70
402125	CM 611 HBDB	YES	12'	24	43
403215	CM 611 HBDB	YES	12'	12	23
390438	CM 611 CVG ⁴⁸	YES	12'	24	43
390164	CM 611 HBRZ	YES	12'	24	43

► Drilled and countersunk, 6" centers for #3 fastener

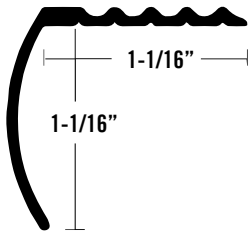



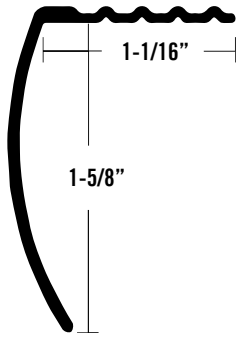

1 1/16" DELUXE STAIR NOSING

ITEM	ITEM DESCRIPTION	NAILS INCL.	LENGTH	QTY	WEIGHT
406102	CM 601 HMF ⁴⁸	NO	12'	40	81
406130	CM 601 HMF ⁴⁸	YES	12'	40	83
406103	CM 601 HB ⁴⁸	NO	12'	40	81
406131	CM 601 HB ⁴⁸	YES	12'	40	83
401214	CM 601 HN ⁴⁸	YES	12'	40	83
406108	CM 601 HBDB	YES	12'	12	27
389135	CM 601 CVG	YES	12'	12	27
401122	CM 601 OAK	YES	12'	24	51
401123	CM 601 CHERRY	YES	12'	24	51
401124	CM 601 GUNSTOCK	YES	12'	24	51

► Drilled and countersunk, 6" centers for #3 fastener



1 5/8" DELUXE STAIR NOSING

ITEM	ITEM DESCRIPTION	NAILS INCL.	LENGTH	QTY	WEIGHT
406160	CM 605 HMF 	NO	12'	12	30
403191	CM 605 HMF 	YES	12'	12	30
406161	CM 605 HB 	NO	12'	12	30
403192	CM 605 HB 	YES	12'	12	30
406165	CM 605 HEA	NO	12'	12	30
406159	CM 605 HN 	YES	12'	12	30
403193	CM 605 HBDB	YES	12'	12	30
403240	CM 605 CVG	YES	12'	12	30
403145	CM 605 HBRZ	YES	12'	12	30

▶ Drilled and countersunk, 6" centers for #3 fastener

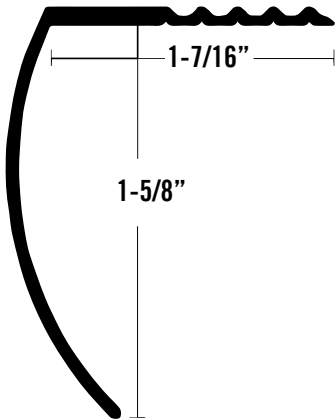

1 5/8" STANDARD WIDE TREAD STAIR NOSING

ITEM	ITEM DESCRIPTION	NAILS INCL.	LENGTH	QTY	WEIGHT
406166	CM 615 HMF 	YES	12'	12	35
406167	CM 615 HB 	YES	12'	12	35
403232	CM 615 HN	YES	12'	12	35

▶ Drilled and countersunk, 6" centers for #10 fastener

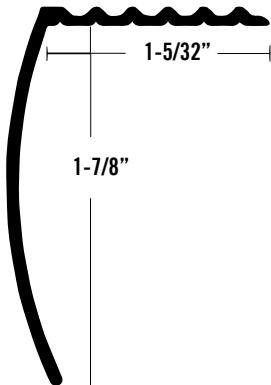

1 7/8" DELUXE STAIR NOSING

ITEM	ITEM DESCRIPTION	NAILS INCL.	LENGTH	QTY	WEIGHT
406182	CM 627 HMF	NO	12'	12	38
406184	CM 627 HB	NO	12'	12	38
406183	CM 627 HN	NO	12'	12	38

▶ Drilled and countersunk, 6" centers for #3 fastener

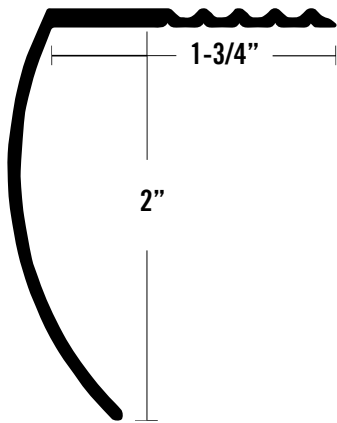

2" STANDARD WIDE TREAD STAIR NOSING

ITEM	ITEM DESCRIPTION	NAILS INCL.	LENGTH	QTY	WEIGHT
406174	CM 617 HMF	NO	12'	12	47
406175	CM 617 HB	NO	12'	12	47

▶ Drilled and countersunk, 6" centers for #3 fastener

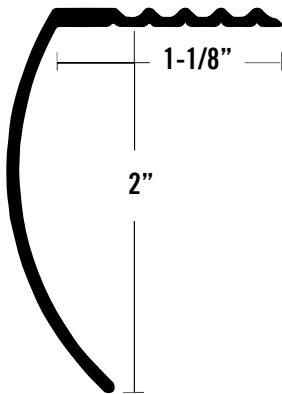

2" DELUXE STAIR NOSING

ITEM	ITEM DESCRIPTION	NAILS INCL.	LENGTH	QTY	WEIGHT
406170	CM 607 HMF	NO	12'	12	41
406171	CM 607 HB	NO	12'	12	41
406176	CM 607 HN	YES	12'	12	42

▶ Drilled and countersunk, 6" centers for #3 fastener

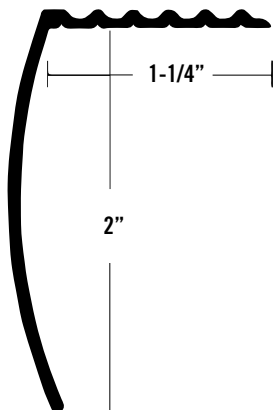

2" DELUXE STAIR NOSING

ITEM	ITEM DESCRIPTION	NAILS INCL.	LENGTH	QTY	WEIGHT
406124	CM 648 HMF	YES	12'	12	37
406126	CM 648 HB	YES	12'	12	37
406127	CM 648 HN	YES	12'	12	37
406125	CM 648 HBDB	YES	12'	12	37

▶ Drilled and countersunk, 6" centers for #3 fastener

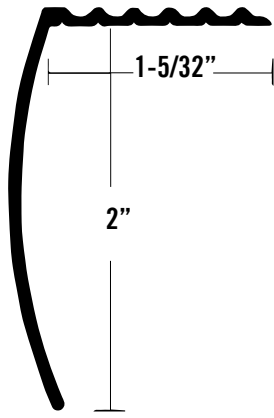

2" DELUXE STAIR NOSING

ITEM	ITEM DESCRIPTION	NAILS INCL.	LENGTH	QTY	WEIGHT
406185	CM 637 HMF	NO	12'	12	39
406186	CM 637 HB	NO	12'	12	39
406189	CM 637 HEA	NO	12'	12	39
406187	CM 637 HN	NO	12'	12	39
406188	CM 637 HBDB	NO	12'	12	39

▶ Drilled and countersunk, 6" centers for #3 fastener

2 1/2" COMMERCIAL STAIR NOSING

ITEM	ITEM DESCRIPTION	NAILS INCL.	LENGTH	QTY	WEIGHT
403188	CM 603 EA	YES	12'	12	39
406144	CM 603 BA	YES	12'	12	39
403189	CM 603 EB	YES	12'	12	39
403266	CM 603 EN	YES	12'	12	39

▶ Drilled and countersunk, 6" centers for #3 fastener

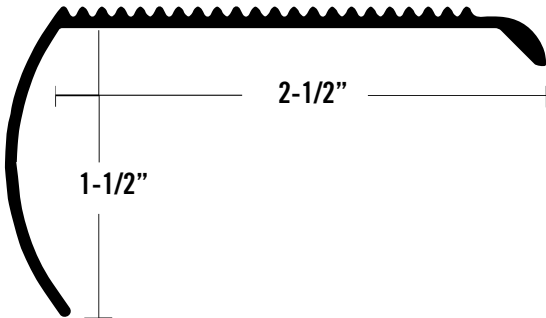

3 1/4" COMMERCIAL STAIR NOSING

ITEM	ITEM DESCRIPTION	NAILS INCL.	LENGTH	QTY	WEIGHT
406180	CM 609 BA	NO	12'	12	62
406181	CM 609 EB	NO	12'	12	62

▶ Drilled and countersunk, 6" centers for #3 fastener

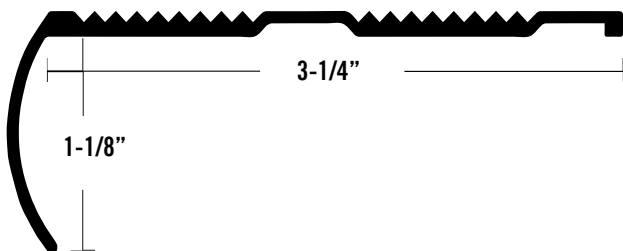



DRIVE NAILS

- Drive nails are used to fasten flooring trims to wood floor.
- Some products come with nails included

COUNTERSUNK OVAL HEAD SCREW NAILS



ITEM	ITEM DESCRIPTION	FINISH	PACK	QTY PER PACK
482066	DRIVE NAIL	CHERRY	24 packs	25
482068	DRIVE NAIL	GUNSTOCK	24 packs	25
482041	DRIVE NAIL	BRASS	40 packs	25
482073	DRIVE NAIL	BLACK	12 packs	25
482059	DRIVE NAIL	BLACK	24 packs	25
482036	DRIVE NAIL	BRASS	50 lbs bulk	-
489008	DRIVE NAIL	BRONZE	24 packs	25
482070	DRIVE NAIL	NICKEL	12 packs	25
482058	DRIVE NAIL	NICKEL	24 packs	25
482072	DRIVE NAIL	OAK	24 packs	25
482026	DRIVE NAIL	SILVER	50 lbs bulk	-
482031	DRIVE NAIL	SILVER	40 packs	25
482063	DRIVE NAIL	NICKEL	50 lbs bulk	-
482071	DRIVE NAIL	BLACK	12 packs	25

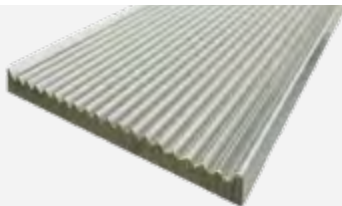

STRAIGHT EDGE

- Straight edge is a useful tool for installers that acts as a guide to cut carpet to have a straight edge.

2 1/2" STRAIGHT EDGE

ITEM	ITEM DESCRIPTION	NAILS INCL.	LENGTH	QTY	WEIGHT
409170	CM 36 EA 	NO	36"	6	21
409171	CM 75 EA 	NO	75"	6	40

► 45° angle, one end only



COVING, SQUARE & BEVEL CAPS

- For coving carpet or resilient floors.
- Coving carpet up walls and cap off for a smooth look.

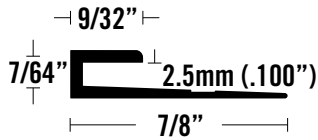

7/64" (2.5MM) SQUARE CAP

ITEM	ITEM DESCRIPTION	NAILS INCL.	LENGTH	QTY	WEIGHT
402028	LVT 925 EA	NO	12'	24	23
402029	LVT 925 EN	NO	12'	24	23
402030	LVT 925 EBRZ	NO	12'	24	23

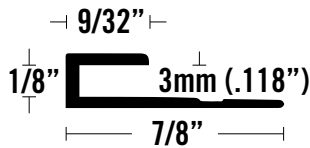

1/8" (3MM) SQUARE CAP

ITEM	ITEM DESCRIPTION	NAILS INCL.	LENGTH	QTY	WEIGHT
402031	LVT 906 EA	NO	12'	24	23
402032	LVT 906 EN	NO	12'	24	23
402033	LVT 906 EBRZ	NO	12'	24	23

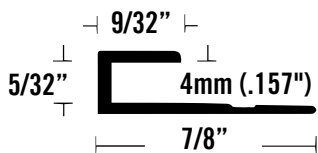

5/32" (4MM) SQUARE CAP

ITEM	ITEM DESCRIPTION	NAILS INCL.	LENGTH	QTY	WEIGHT
403263	LVT 904 EA	NO	12'	24	22
403264	LVT 904 EN	NO	12'	24	22
403265	LVT 904 BRZ	NO	12'	24	22

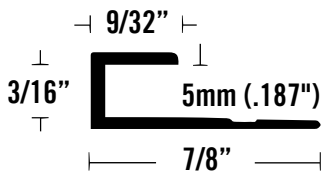

3/16" (5MM) SQUARE CAP

ITEM	ITEM DESCRIPTION	NAILS INCL.	LENGTH	QTY	WEIGHT
403262	LVT 905 EA	NO	12'	24	22
403261	LVT 905 EN	NO	12'	24	22
403260	LVT 905 BRZ	NO	12'	24	22

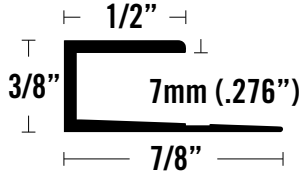

3/8" (7MM) SQUARE CAP

ITEM	ITEM DESCRIPTION	NAILS INCL.	LENGTH	QTY	WEIGHT
402034	LVT 907 EA	NO	12'	24	29
402035	LVT 907 EN	NO	12'	24	29
402036	LVT 907 EBRZ	NO	12'	24	29

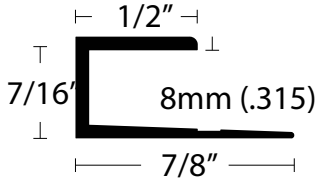

7/16" (8MM) SQUARE CAP

ITEM	ITEM DESCRIPTION	NAILS INCL.	LENGTH	QTY	WEIGHT
402062	LVT 908 EA	NO	12'	24	30
402063	LVT 908 EN	NO	12'	24	30
402064	LVT 908 EBRZ	NO	12'	24	30

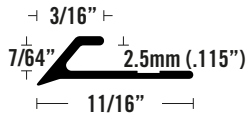

7/64" (2.5MM) BEVEL CAP

ITEM	ITEM DESCRIPTION	NAILS INCL.	LENGTH	QTY	WEIGHT
402022	LVT 425 EA	NO	12'	24	18
402023	LVT 425 EN	NO	12'	24	18
402024	LVT 425 EBRZ	NO	12'	24	18

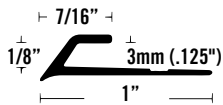

1/8" (3MM) BEVEL CAP

ITEM	ITEM DESCRIPTION	NAILS INCL.	LENGTH	QTY	WEIGHT
390156	LVT 406 EA	NO	12'	24	26
390157	LVT 406 EN	NO	12'	24	26
390158	LVT 406 BRZ	NO	12'	24	26

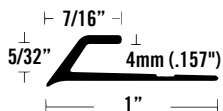

5/32" (4MM) BEVEL CAP

ITEM	ITEM DESCRIPTION	NAILS INCL.	LENGTH	QTY	WEIGHT
390153	LVT 404 EA	NO	12'	24	27
390154	LVT 404 EN	NO	12'	24	27
390155	LVT 404 BRZ	NO	12'	24	27

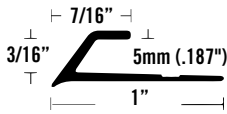

3/16" (5MM) BEVEL CAP

ITEM	ITEM DESCRIPTION	NAILS INCL.	LENGTH	QTY	WEIGHT
390159	LVT 405 EA	NO	12'	24	28
390160	LVT 405 EN	NO	12'	24	28
390161	LVT 405 BRZ	NO	12'	24	28

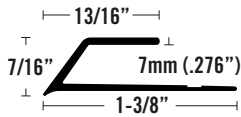

7/16" (7MM) BEVEL CAP

ITEM	ITEM DESCRIPTION	NAILS INCL.	LENGTH	QTY	WEIGHT
402025	LVT 407 EA	NO	12'	24	41
402026	LVT 407 EN	NO	12'	24	41
402027	LVT 407 EBRZ	NO	12'	24	41

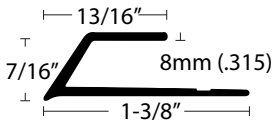

7/16" (8MM) BEVEL CAP

ITEM	ITEM DESCRIPTION	NAILS INCL.	LENGTH	QTY	WEIGHT
402071	LVT 408 EA	NO	12'	24	41
402072	LVT 408 EN	NO	12'	24	41
402073	LVT 408 EBRZ	NO	12'	24	41

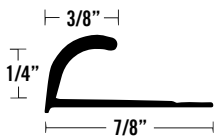

1/4" ROUND COVING CAP

ITEM	ITEM DESCRIPTION	NAILS INCL.	LENGTH	QTY	WEIGHT
404049	CM 400 HMF	NO	12'	40	39
404050	CM 400 HB	NO	12'	40	39

► No fabrication. Nail starter lines

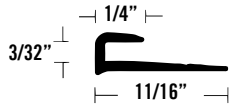



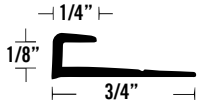

3/32" COVING CAP

ITEM	ITEM DESCRIPTION	NAILS INCL.	LENGTH	QTY	WEIGHT
409155	CM 903 MFA 	NO	12'	40	26
409165	CM 903 EB	NO	12'	40	26
410817	CM 903 EN	NO	12'	24	17

► Punched and slotted on 2" centers



1/8" COVING CAP

ITEM	ITEM DESCRIPTION	NAILS INCL.	LENGTH	QTY	WEIGHT
409110	CM 901 HMF	NO	8'	60	31
409115	CM 901 HMF 	NO	12'	40	32
409130	CM 901 MFA 	NO	8'	60	31
409105	CM 901 MFA 	NO	12'	40	32
409125	CM 901 HB	NO	12'	40	32
409135	CM 901 MFB 	NO	8'	60	31
409126	CM 901 MFB	NO	12'	12	12
530706	CM 901 HN	NO	12'	24	21
409986	CM 901 EN	NO	12'	40	32

► Punched and slotted on 2" centers

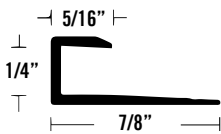

1/4" COVING CAP

ITEM	ITEM DESCRIPTION	NAILS INCL.	LENGTH	QTY	WEIGHT
409956	CM 401 HMF	NO	12'	40	36
409980	CM 401 MFA 	NO	12'	40	36
404101	CM 401 BA	NO	12'	40	36
409955	CM 401 HB	NO	12'	40	36
409981	CM 401 MFB	NO	12'	40	36
409985	CM 401 EN	NO	12'	40	36

► Punched and slotted on 2" centers

LVT TRIMS & TRANSITIONS

Introducing our latest line of trims and transitions made specifically for the expanding LVT/Resilient market.

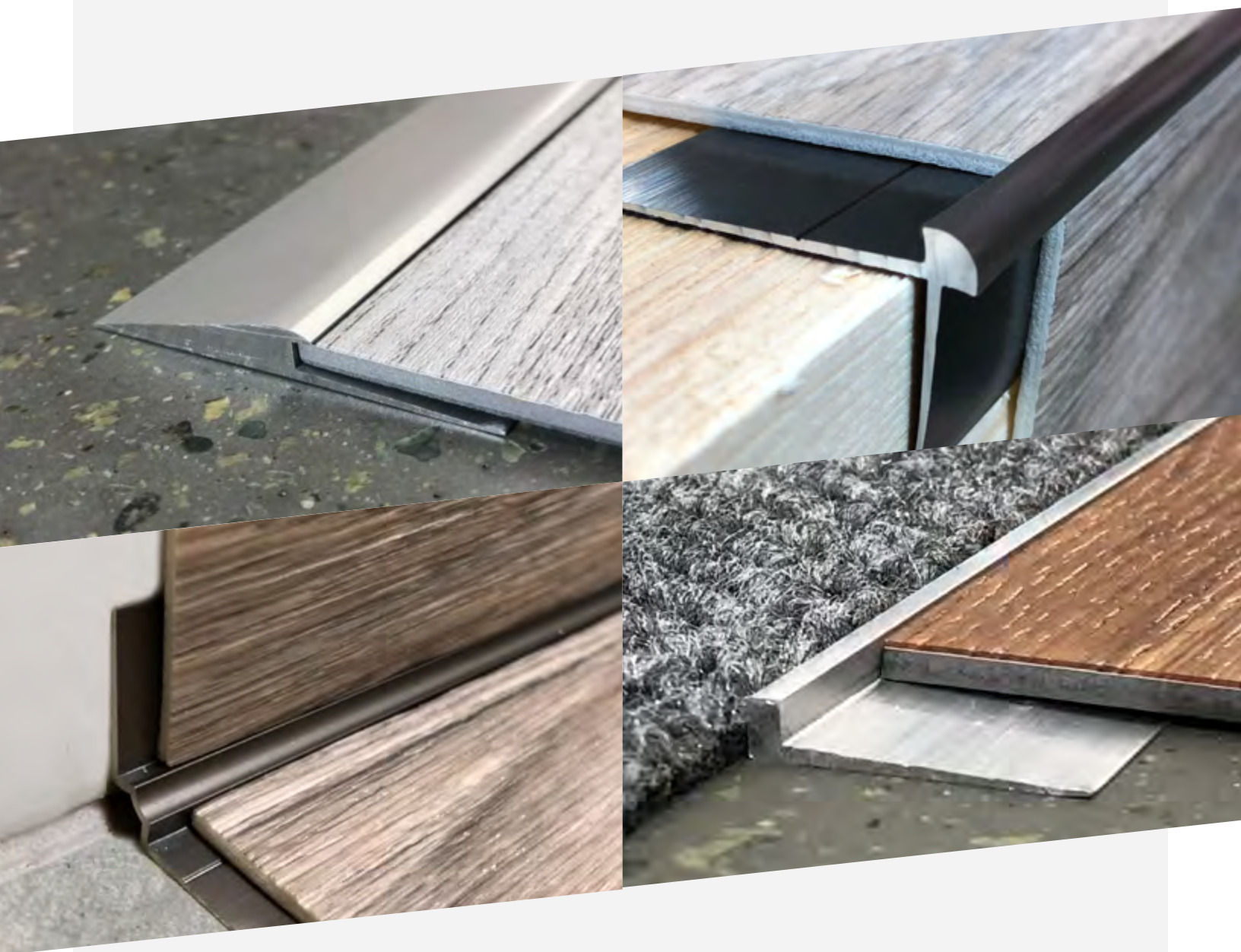

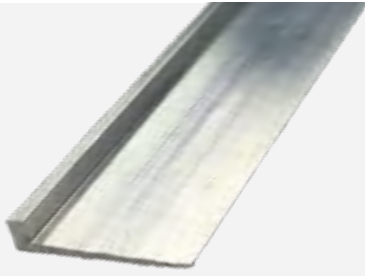

LVT REDUCERS

- Transition from LVT to carpet tile.
- Transition from LVT to nothing.
- Transition from LVT to other resilient.



7/64" (2.5MM to 4.5mm) LVT NO-LIP RAMP

ITEM	ITEM DESCRIPTION	NAILS INCL.	LENGTH	QTY	WEIGHT
402052	LVT 124 MF	NO	12'	24	25

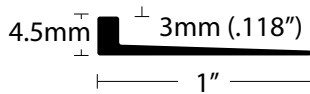

1/8" (3MM to 4.5MM) LVT NO-LIP RAMP

ITEM	ITEM DESCRIPTION	NAILS INCL.	LENGTH	QTY	WEIGHT
402021	LVT 125 MF	NO	12'	24	21

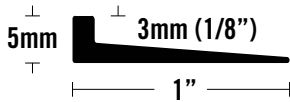

1/8" (3MM to 5MM) LVT NO-LIP RAMP

ITEM	ITEM DESCRIPTION	NAILS INCL.	LENGTH	QTY	WEIGHT
402051	LVT 127 MF	NO	12'	24	26

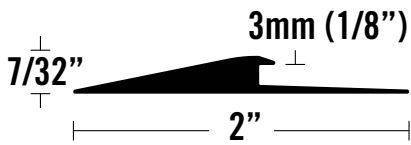

1/8" (3MM) LVT REDUCER

ITEM	ITEM DESCRIPTION	NAILS INCL.	LENGTH	QTY	WEIGHT
402068	LVT 113 EA	NO	12'	24	66
402069	LVT 113 EN	NO	12'	24	66
402070	LVT 113 EBRZ	NO	12'	24	66

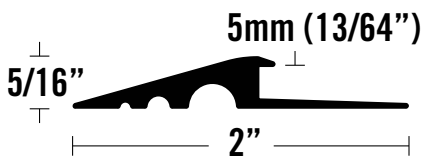

13/64" (5MM) LVT REDUCER

ITEM	ITEM DESCRIPTION	NAILS INCL.	LENGTH	QTY	WEIGHT
402065	LVT 115 EA	NO	12'	24	67
402066	LVT 115 EN	NO	12'	24	67
402067	LVT 115 EBRZ	NO	12'	24	67

19/32" (15MM to 3MM) LVT RAMP

ITEM	ITEM DESCRIPTION	NAILS INCL.	LENGTH	QTY	WEIGHT
402009	LVT 126 MF	NO	12'	6	57

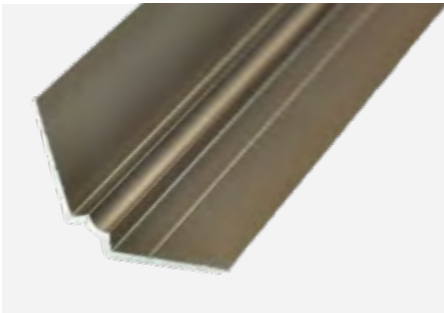
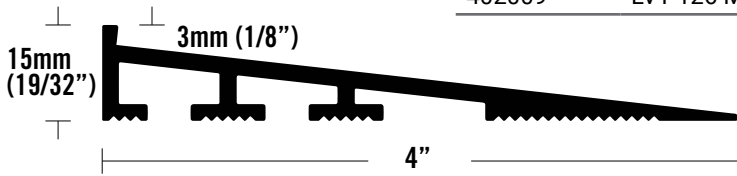

STAIR CORNERS

- LVT transitions for both the inside and outside corners of stairs.
- LVT transitions for both inside and outside corners of wall applications.

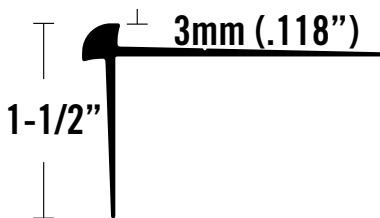

1/8" (3MM) STAIR NOSING TREAD TRANSITION

ITEM	ITEM DESCRIPTION	NAILS INCL.	LENGTH	QTY	WEIGHT
402018	LVT 340 EA	NO	12'	12	24
402019	LVT 340 EN	NO	12'	12	24
402020	LVT 340 EBRZ	NO	12'	12	24

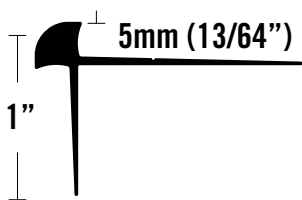

13/64" (5MM) STAIR NOSING TREAD TRANSITION

ITEM	ITEM DESCRIPTION	NAILS INCL.	LENGTH	QTY	WEIGHT
402046	LVT 341 EA	NO	12'	12	28
402047	LVT 341 EN	NO	12'	12	28
402048	LVT 341 EBRZ	NO	12'	12	28

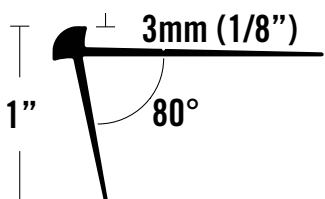

1/8" (3MM) STAIR NOSING TREAD TRANSITION

ITEM	ITEM DESCRIPTION	NAILS INCL.	LENGTH	QTY	WEIGHT
402011	LVT 342 EA	NO	12'	12	24
402012	LVT 342 EN	NO	12'	12	24
402013	LVT 342 EBRZ	NO	12'	12	24

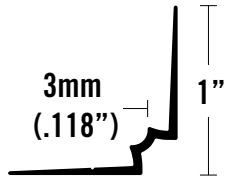

1/8" (3MM) STAIR RISER

ITEM	ITEM DESCRIPTION	NAILS INCL.	LENGTH	QTY	WEIGHT
402015	LVT 330 EA	NO	12'	12	18
402016	LVT 330 EN	NO	12'	12	18
402017	LVT 330 EBRZ	NO	12'	12	18

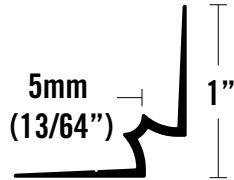

13/64" (5MM) STAIR RISER

ITEM	ITEM DESCRIPTION	NAILS INCL.	LENGTH	QTY	WEIGHT
402014	LVT 331 EA	NO	12'	12	19
402049	LVT 331 EN	NO	12'	12	19
402050	LVT 331 EBRZ	NO	12'	12	19



STAIR NOSING

- Two different drops, 1-5/8" and 2"
- Available in various sizes

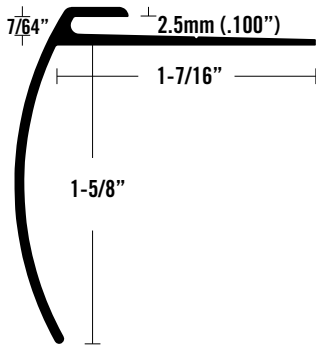

7/64" (2.5MM) LVT STAIR NOSING

ITEM	ITEM DESCRIPTION	NAILS INCL.	LENGTH	QTY	WEIGHT
402037	LVT 625 EA	NO	12'	12	36
402038	LVT 625 EN	NO	12'	12	36
402039	LVT 625 EBRZ	NO	12'	12	36

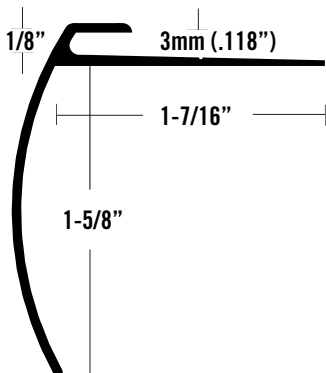

1/8" (3MM) LVT STAIR NOSING

ITEM	ITEM DESCRIPTION	NAILS INCL.	LENGTH	QTY	WEIGHT
402040	LVT 630 EA	NO	12'	12	37
402041	LVT 630 EN	NO	12'	12	37
402042	LVT 630 EBRZ	NO	12'	12	37

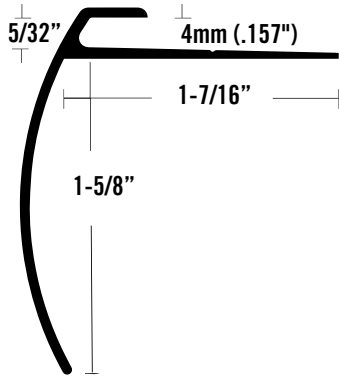

5/32" (4MM) LVT STAIR NOSING

ITEM	ITEM DESCRIPTION	NAILS INCL.	LENGTH	QTY	WEIGHT
401176	LVT 606 EA	NO	12'	12	37
401177	LVT 606 EN	NO	12'	12	37
401175	LVT 606 EBRZ	NO	12'	12	37

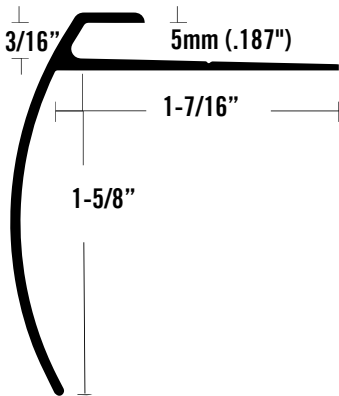

3/16" (5MM) LVT STAIR NOSING

ITEM	ITEM DESCRIPTION	NAILS INCL.	LENGTH	QTY	WEIGHT
389141	LVT 608 EA	NO	12'	12	37
389143	LVT 608 EN	NO	12'	12	37
390168	LVT 608 EBRZ	NO	12'	12	37
389142	LVT 608 EB	NO	12'	12	37

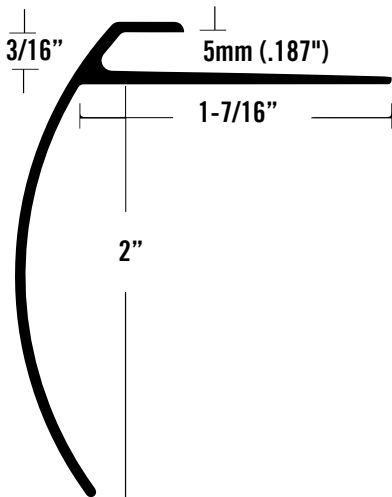

3/16" (5MM) LVT STAIR NOSING LONG

ITEM	ITEM DESCRIPTION	NAILS INCL.	LENGTH	QTY	WEIGHT
401178	LVT 610 EA	NO	12'	12	41
401179	LVT 610 EN	NO	12'	12	41
401180	LVT 610 EBRZ	NO	12'	12	41

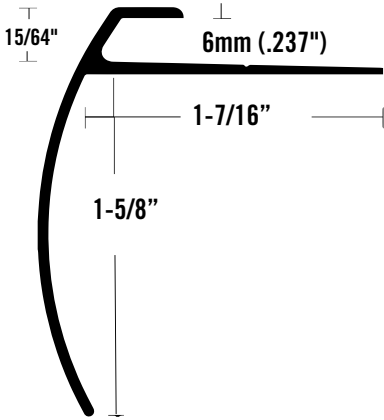

15/64" (6MM) LVT STAIR NOSING

ITEM	ITEM DESCRIPTION	NAILS INCL.	LENGTH	QTY	WEIGHT
401197	LVT 604 EA	NO	12'	12	37
401198	LVT 604 EN	NO	12'	12	37
401196	LVT 604 EBRZ	NO	12'	12	37

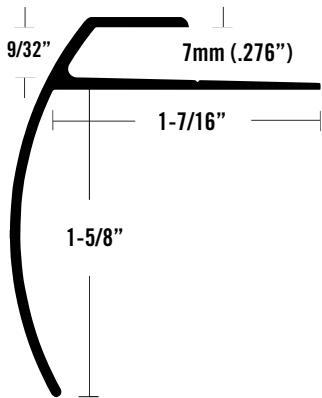

9/32" (7MM) LVT STAIR NOSING

ITEM	ITEM DESCRIPTION	NAILS INCL.	LENGTH	QTY	WEIGHT
402043	LVT 612 EA	NO	12'	12	40
402044	LVT 612 EN	NO	12'	12	40
402045	LVT 612 EBRZ	NO	12'	12	40

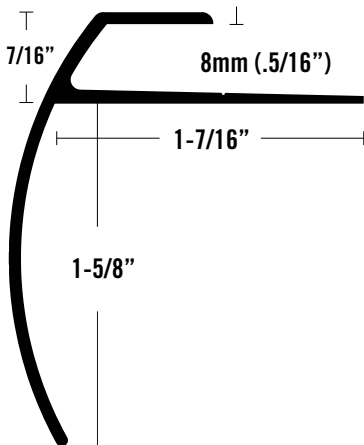

7/16" (8MM) LVT STAIR NOSING

ITEM	ITEM DESCRIPTION	NAILS INCL.	LENGTH	QTY	WEIGHT
402059	LVT 618 EA	NO	12'	12	40
402060	LVT 618 EN	NO	12'	12	40
402061	LVT 618 EBRZ	NO	12'	12	40



BEVEL CAPS

- Transitions from LVT to carpet, concrete, or flooring of lesser height.
- Can be used as end cap in wall application.

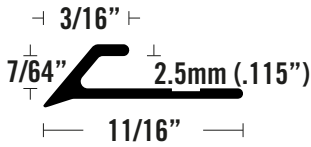

7/64" (2.5MM) BEVEL CAP

ITEM	ITEM DESCRIPTION	NAILS INCL.	LENGTH	QTY	WEIGHT
402022	LVT 425 EA	NO	12'	24	18
402023	LVT 425 EN	NO	12'	24	18
402024	LVT 425 EBRZ	NO	12'	24	18

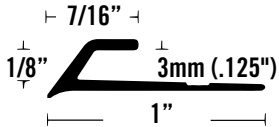

1/8" (3MM) BEVEL CAP

ITEM	ITEM DESCRIPTION	NAILS INCL.	LENGTH	QTY	WEIGHT
390156	LVT 406 EA	NO	12'	24	26
390157	LVT 406 EN	NO	12'	24	26
390158	LVT 406 EBRZ	NO	12'	24	26

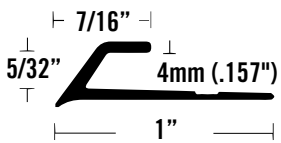

5/32" (4MM) BEVEL CAP

ITEM	ITEM DESCRIPTION	NAILS INCL.	LENGTH	QTY	WEIGHT
390153	LVT 404 EA	NO	12'	24	27
390154	LVT 404 EN	NO	12'	24	27
390155	LVT 404 EBRZ	NO	12'	24	27

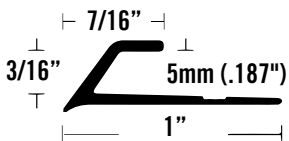

3/16" (5MM) BEVEL CAP

ITEM	ITEM DESCRIPTION	NAILS INCL.	LENGTH	QTY	WEIGHT
390159	LVT 405 EA	NO	12'	24	28
390160	LVT 405 EN	NO	12'	24	28
390161	LVT 405 EBRZ	NO	12'	24	28

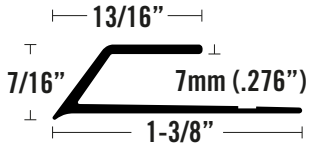

7/16" (7MM) BEVEL CAP

ITEM	ITEM DESCRIPTION	NAILS INCL.	LENGTH	QTY	WEIGHT
402025	LVT 407 EA	NO	12'	24	41
402026	LVT 407 EN	NO	12'	24	41
402027	LVT 407 EBRZ	NO	12'	24	41

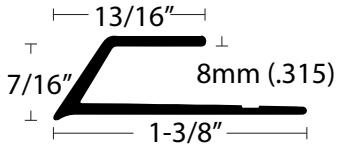

7/16" (8MM) BEVEL CAP

ITEM	ITEM DESCRIPTION	NAILS INCL.	LENGTH	QTY	WEIGHT
402071	LVT 408 EA	NO	12'	24	41
402072	LVT 408 EN	NO	12'	24	41
402073	LVT 408 EBRZ	NO	12'	24	41





SQUARE CAPS

- Transitions from LVT to ceramic tile, wood or other surfaces of equal height.
- Can be used as end cap in wall application or LVT to fixture such as bathtub or vanity

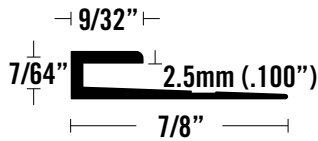

7/64" (2.5MM) SQUARE CAP

ITEM	ITEM DESCRIPTION	NAILS INCL.	LENGTH	QTY	WEIGHT
402028	LVT 925 EA	NO	12'	24	23
402029	LVT 925 EN	NO	12'	24	23
402030	LVT 925 EBRZ	NO	12'	24	23

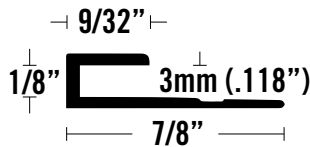

1/8" (3MM) SQUARE CAP

ITEM	ITEM DESCRIPTION	NAILS INCL.	LENGTH	QTY	WEIGHT
402031	LVT 906 EA	NO	12'	24	23
402032	LVT 906 EN	NO	12'	24	23
402033	LVT 906 EBRZ	NO	12'	24	23

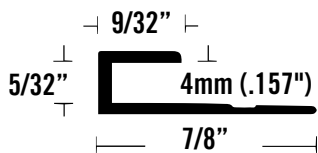

5/32" (4MM) SQUARE CAP

ITEM	ITEM DESCRIPTION	NAILS INCL.	LENGTH	QTY	WEIGHT
403263	LVT 904 EA	NO	12'	24	22
403264	LVT 904 EN	NO	12'	24	22
403265	LVT 904 EBRZ	NO	12'	24	22

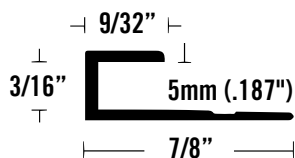

3/16" (5MM) SQUARE CAP

ITEM	ITEM DESCRIPTION	NAILS INCL.	LENGTH	QTY	WEIGHT
403262	LVT 905 EA	NO	12'	24	22
403261	LVT 905 EN	NO	12'	24	22
403260	LVT 905 EBRZ	NO	12'	24	22

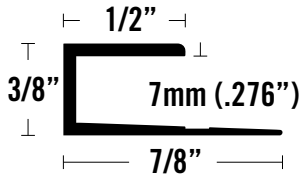

3/8" (7MM) SQUARE CAP

ITEM	ITEM DESCRIPTION	NAILS INCL.	LENGTH	QTY	WEIGHT
402034	LVT 907 EA	NO	12'	24	29
402035	LVT 907 EN	NO	12'	24	29
402036	LVT 907 EBRZ	NO	12'	24	29

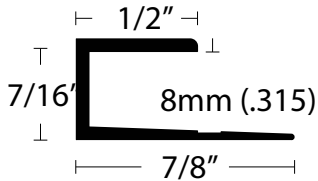

7/16" (8MM) SQUARE CAP

ITEM	ITEM DESCRIPTION	NAILS INCL.	LENGTH	QTY	WEIGHT
402062	LVT 908 EA	NO	12'	24	30
402063	LVT 908 EN	NO	12'	24	30
402064	LVT 908 EBRZ	NO	12'	24	30



CERAMIC TILE TO LVT

- Transition from tile to lower elevation LVT flooring that is already installed.
- Lays over an uneven end of LVT flooring, reduces rework time.

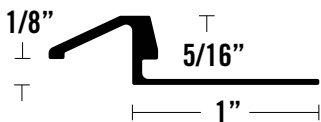

5/16" CERAMIC TILE TO LVT (3MM)

ITEM	ITEM DESCRIPTION	NAILS INCL.	LENGTH	QTY	WEIGHT
415336	LVT 230 EA	NO	12'	12	13
415338	LVT 230 EN	NO	12'	12	13

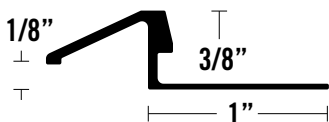

3/8" CERAMIC TILE TO LVT (3MM)

ITEM	ITEM DESCRIPTION	NAILS INCL.	LENGTH	QTY	WEIGHT
415318	LVT 235 EA	NO	12'	12	14
415319	LVT 235 EN	NO	12'	12	14
415325	LVT 235 EBRZ	NO	12'	12	14
415320	LVT 235 BDB	NO	12'	12	14



CARPET TILE TO LVT

- Transitions from carpet tile to LVT of 3 or 5 mm height.

1/8" (3MM) CARPET TILE TO LVT

ITEM	ITEM DESCRIPTION	NAILS INCL.	LENGTH	QTY	WEIGHT
402000	LVT 130 EA	NO	12'	24	31
402001	LVT 130 EN	NO	12'	24	31
402002	LVT 130 EBRZ	NO	12'	24	31

3/16" (5MM) CARPET TILE TO LVT

ITEM	ITEM DESCRIPTION	NAILS INCL.	LENGTH	QTY	WEIGHT
402003	LVT 150 EA	NO	12'	24	32
402004	LVT 150 EN	NO	12'	24	32
402005	LVT 150 EBRZ	NO	12'	24	32

3/16" (5MM) CARPET TILE TO LVT/NOTHING

ITEM	ITEM DESCRIPTION	NAILS INCL.	LENGTH	QTY	WEIGHT
402006	LVT 160 EA	NO	12'	24	34
402007	LVT 160 EN	NO	12'	24	34
402008	LVT 160 EBRZ	NO	12'	24	34

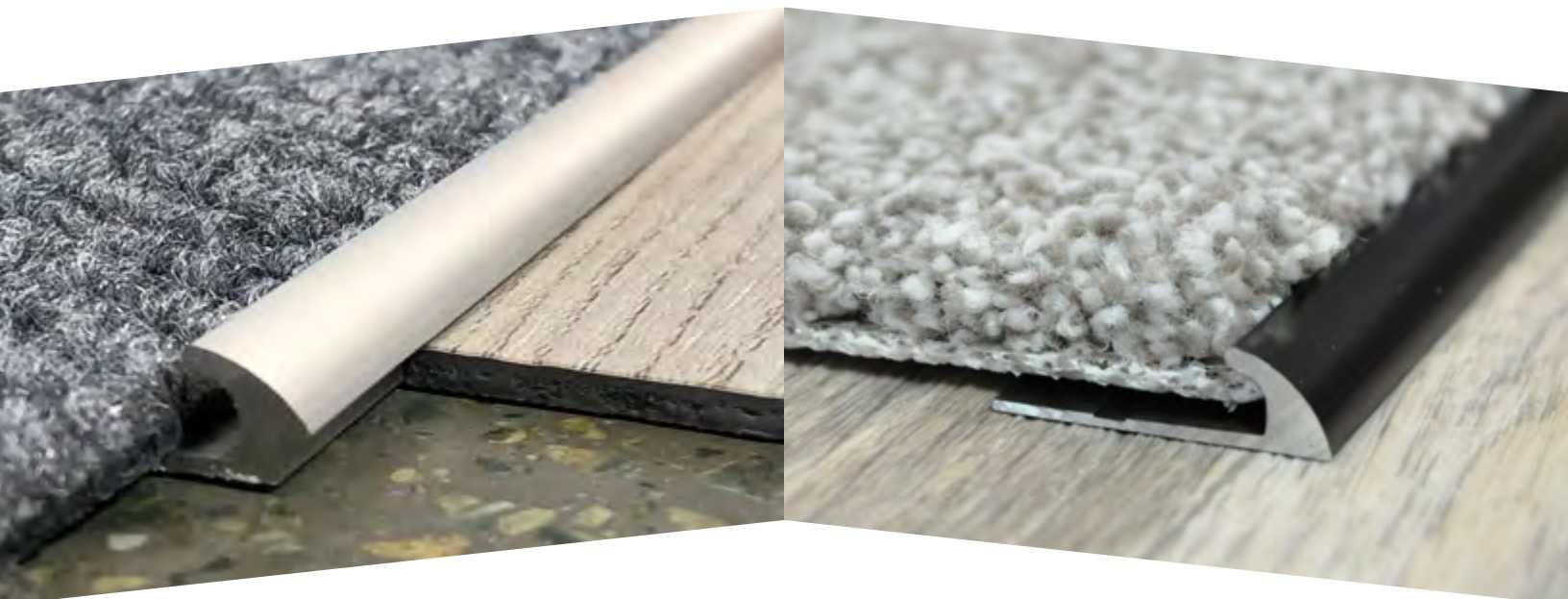
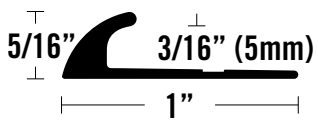
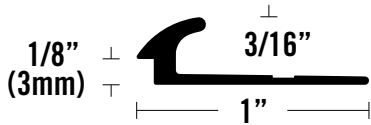

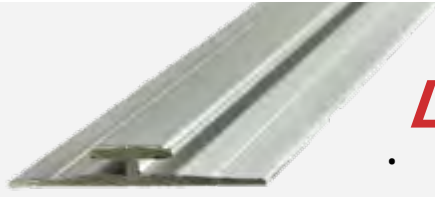

LVT JOINERS

- Aluminum divider used to join LVT of same height where seam is needed.

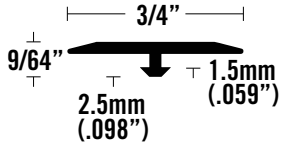

7/64" (2.5MM) LVT JOINER

ITEM	ITEM DESCRIPTION	NAILS INCL.	LENGTH	QTY	WEIGHT
402074	LVT 102 EA	NO	12'	24	19
402075	LVT 102 EN	NO	12'	24	19
402076	LVT 102 EBRZ	NO	12'	24	19

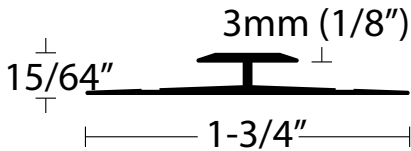

1/8" (3MM) LVT JOINER

ITEM	ITEM DESCRIPTION	NAILS INCL.	LENGTH	QTY	WEIGHT
402056	LVT 103 EA	NO	12'	24	36
402057	LVT 103 EN	NO	12'	24	36
402058	LVT 103 EBRZ	NO	12'	24	36

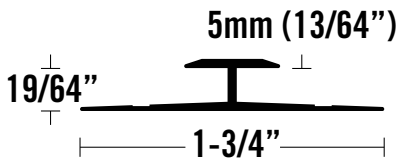

13/64" (5MM) LVT JOINER

ITEM	ITEM DESCRIPTION	NAILS INCL.	LENGTH	QTY	WEIGHT
402053	LVT 105 EA	NO	12'	24	38
402054	LVT 105 EN	NO	12'	24	38
402055	LVT 105 EBRZ	NO	12'	24	38

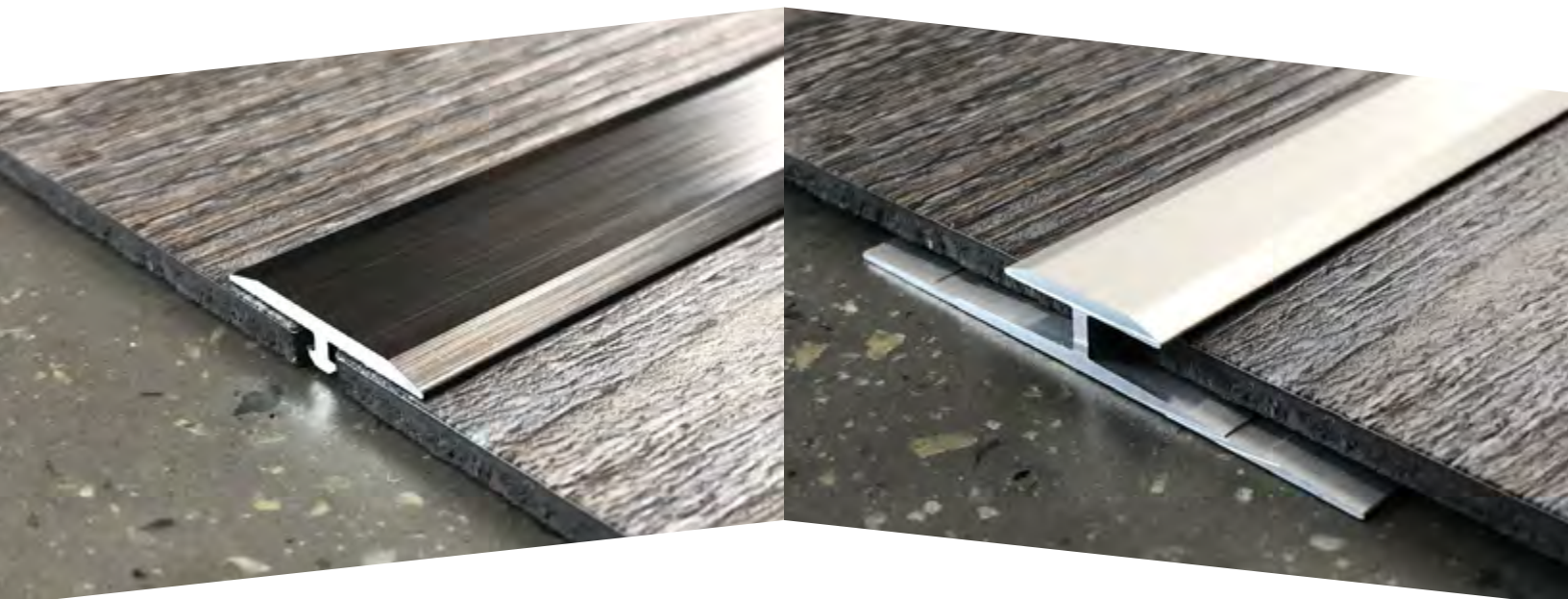

CERAMIC FLOORING TRIMS

Featuring Edgetek™



edgetek™

CREATING THE PERFECT GROUT LINE

EdgeTek™ has been engineered to create a perfect grout line by extruding a feature into the product that holds the tile the perfect distance from the reveal along the length of the trim. This allows you to create a perfectly straight grout line that looks great every time.

Look for the  symbol to select trim featuring Edgetek feature.



L SHAPE TRIMS

- Provides edge on tiles that eliminates chipping and cracking of tile.
- Allows for straight edge grout line each time on Edgetek trims.

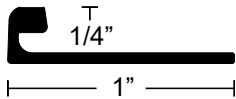

1/4" EDGETEK L SHAPE

ITEM	ITEM DESCRIPTION	NAILS INCL.	LENGTH	QTY	WEIGHT
415312	EdgeTek L 14 EA	NO	98.5"	12	12
415315	EdgeTek L 14 EN	NO	98.5"	12	12
415317	EdgeTek L 14 EB	NO	98.5"	12	12



1/4" TILE TRIM

ITEM	ITEM DESCRIPTION	NAILS INCL.	LENGTH	QTY	WEIGHT
415010	TT 14 EA	NO	96"	12	12
415097	TT 14 EN	NO	96"	12	12
415096	TT 14 EB	NO	96"	12	12

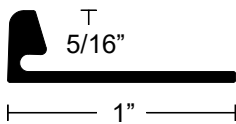

5/16" EDGETEK L SHAPE

ITEM	ITEM DESCRIPTION	NAILS INCL.	LENGTH	QTY	WEIGHT
415130	EdgeTek L 516 MF	NO	98.5"	12	12
415131	EdgeTek L 516 EA	NO	98.5"	12	12
415132	EdgeTek L 516 EN	NO	98.5"	12	12
415270	EdgeTek L 516 EB	NO	98.5"	12	12
415284	EdgeTek L 516 BDB	NO	98.5"	12	12
415233	EdgeTek L 516 EBRNZ	NO	98.5"	12	12
415282	EdgeTek L 516 EBLK	NO	98.5"	12	12
415239	EdgeTek L 516 PVC BRIGHT WHITE	NO	98.5"	12	12

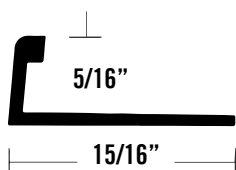

5/16" TILE TRIM

ITEM	ITEM DESCRIPTION	NAILS INCL.	LENGTH	QTY	WEIGHT
415020	TT 516 EA	NO	96"	12	8
415032	TT 516 EN	NO	96"	12	8

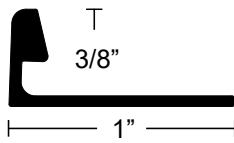

3/8" EDGETEK L SHAPE

ITEM	ITEM DESCRIPTION	NAILS INCL.	LENGTH	QTY	WEIGHT
415133	EdgeTek L 38 MF	NO	98.5"	12	13
415228	EdgeTek L 38 EA	NO	98.5"	12	13
415229	EdgeTek L 38 EN	NO	98.5"	12	13
415289	EdgeTek L 38 EB	NO	98.5"	12	13
415287	EdgeTek L 38 BDB	NO	98.5"	12	13
415230	EdgeTek L 38 EBRNZ	NO	98.5"	12	13
415285	EdgeTek L 38 EBLK	NO	98.5"	12	13
415238	EdgeTek L 38 PVC SAND PEBBLE	NO	98.5"	12	12

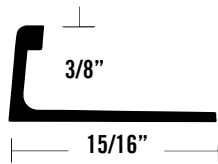

3/8" TILE TRIM

ITEM	ITEM DESCRIPTION	NAILS INCL.	LENGTH	QTY	WEIGHT
415030	TT 38 EA	NO	96"	12	8
415038	TT 38 EN	NO	96"	12	8

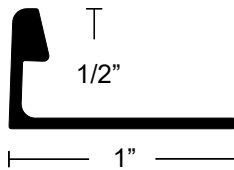

1/2" EDGETEK L SHAPE

ITEM	ITEM DESCRIPTION	NAILS INCL.	LENGTH	QTY	WEIGHT
415129	EdgeTek L 12 MF	NO	98.5"	12	13
415128	EdgeTek L 12 EA	NO	98.5"	12	13
415134	EdgeTek L12 EN	NO	98.5"	12	13
415295	EdgeTek L12 EB	NO	98.5"	12	13
415294	EdgeTek L12 BDB	NO	98.5"	12	13
415301	EdgeTek L 12 EBRNZ	NO	98.5"	12	13
415291	EdgeTek L12 EBLK	NO	98.5"	12	13

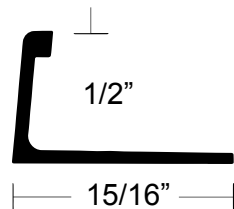

1/2" TILE TRIM

ITEM	ITEM DESCRIPTION	NAILS INCL.	LENGTH	QTY	WEIGHT
415040	TT 12 EA	NO	96"	12	8
415099	TT 12 EN	NO	96"	12	8
415098	TT 12 EB	NO	96"	12	8
415045	TT 12 BDB	NO	96"	12	8
415157	TT 12 EBLK	NO	96"	12	8

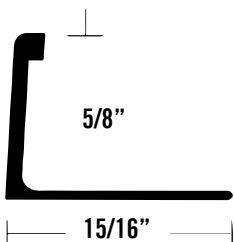

5/8" TILE TRIM

ITEM	ITEM DESCRIPTION	NAILS INCL.	LENGTH	QTY	WEIGHT
415054	TT 58 EA	NO	96"	12	9



TILE REDUCERS

- Protects edges from chipping or cracking while transitioning tile to another surface or unequal height.
- Allows for straight edge grout line each time

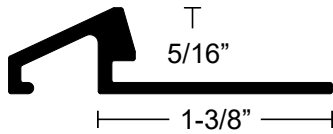

5/16" EDGETEK TILE REDUCER

ITEM	ITEM DESCRIPTION	NAILS INCL.	LENGTH	QTY	WEIGHT
415226	EdgeTek U 516 EA	NO	98.5"	12	16
415227	EdgeTek U 516 EN	NO	98.5"	12	16
415304	EdgeTek U 516 EBRNZ	NO	98.5"	12	16

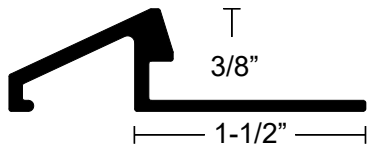

3/8" EDGETEK TILE REDUCER

ITEM	ITEM DESCRIPTION	NAILS INCL.	LENGTH	QTY	WEIGHT
415034	EdgeTek U 38 EA	NO	98.5"	12	18
415056	EdgeTek U 38 EN	NO	98.5"	12	18
415305	EdgeTek U 38 EBRNZ	NO	98.5"	12	18



ROUND BULLNOSE

- Edge protecting profile for outside corners of tiled surfaces.
- Allows for coordination of finishes within a given area.

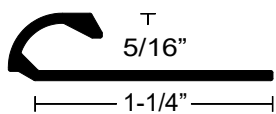

5/16" EDGETEK TILE BULLNOSE

ITEM	ITEM DESCRIPTION	NAILS INCL.	LENGTH	QTY	WEIGHT
415277	EdgeTek R 516 EA	NO	98.5"	12	13
415126	EdgeTek R 516 EN	NO	98.5"	12	13
415279	EdgeTek R 516 EB	NO	98.5"	12	13
415237	EdgeTek R 516 POLALM	NO	98.5"	12	13
415302	EdgeTek R 516 EBRNZ	NO	98.5"	12	13

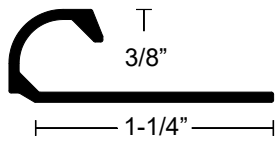

3/8" EDGETEK TILE BULLNOSE

ITEM	ITEM DESCRIPTION	NAILS INCL.	LENGTH	QTY	WEIGHT
415273	EdgeTek R 38 EA	NO	98.5"	12	14
415127	EdgeTek R 38 EN	NO	98.5"	12	14
415275	EdgeTek R 38 EB	NO	98.5"	12	14
415236	EdgeTek R 38 POLALM	NO	98.5"	12	14
415303	EdgeTek R 38 EBRNZ	NO	98.5"	12	14
415331	EdgeTek PVC R 38 BRIGHT WHITE	NO	98.5"	12	14
415240	EdgeTek PVC R 38 SAND PEBBLE	NO	98.5"	12	14



CERAMIC TILE TO LVT

- Transition from tile to lower elevation LVT flooring that is already installed.
- Lays over an uneven end of LVT flooring, reduces rework time.

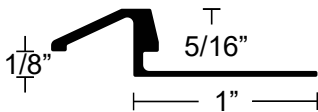

5/16" EDGETEK TILE TO LVT

ITEM	ITEM DESCRIPTION	NAILS INCL.	LENGTH	QTY	WEIGHT
415337	EdgeTek TLVT 516 EA	NO	98.5"	12	15
415339	EdgeTek TLVT 516 EN	NO	98.5"	12	15

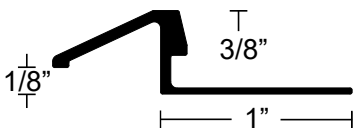

3/8" EDGETEK TILE TO LVT

ITEM	ITEM DESCRIPTION	NAILS INCL.	LENGTH	QTY	WEIGHT
415323	EdgeTek TLVT 38 EA	NO	98.5"	12	15
415322	EdgeTek TLVT 38 EN	NO	98.5"	12	15
415329	EdgeTek TLVT 38 BRZ	NO	98.5"	12	15
415321	EdgeTek TLVT 38 BDB	NO	98.5"	12	15



CARPET TUCK

- Edge protecting profile for outside corner walls of tiled edges.
- Transitions from tile to carpet

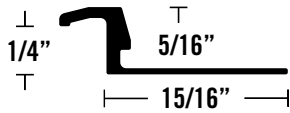

5/16" EDGETEK CARPET TUCK

ITEM	ITEM DESCRIPTION	NAILS INCL.	LENGTH	QTY	WEIGHT
415358	EdgeTek CT 516 EA	NO	98.5"	12	12
415360	EdgeTek CT 516 EN	NO	98.5"	12	12

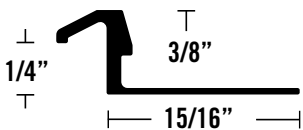

3/8" EDGETEK CARPET TUCK

ITEM	ITEM DESCRIPTION	NAILS INCL.	LENGTH	QTY	WEIGHT
415359	EdgeTek CT 38 EA	NO	98.5"	12	13
415361	EdgeTek CT 38 EN	NO	98.5"	12	13
415363	EdgeTek CT 38 BRZ	NO	98.5"	12	13
415362	EdgeTek CT 38 BDB	NO	98.5"	12	13

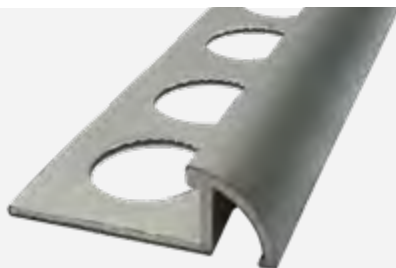

TILE QUARTER ROUND

- Edge protecting profile for outside corner walls of tiled edges.

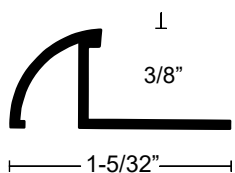

3/8" CERAMIC QUARTER ROUND

ITEM	ITEM DESCRIPTION	NAILS INCL.	LENGTH	QTY	WEIGHT
415341	EdgeTek TQ 38 EA	NO	98.5"	12	12
415343	EdgeTek TQ 38 EN	NO	98.5"	12	12



STAIR NOSING

- Basic nosing for steps.
- Provides finished edge on steps or counter tops.

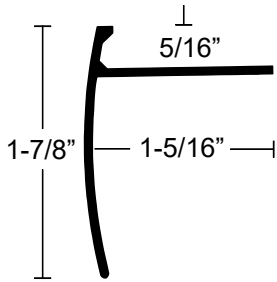

5/16" STAIR NOSING

ITEM	ITEM DESCRIPTION	NAILS INCL.	LENGTH	QTY	WEIGHT
415332	EdgeTek TSN 516 EN	NO	98.5"	12	23

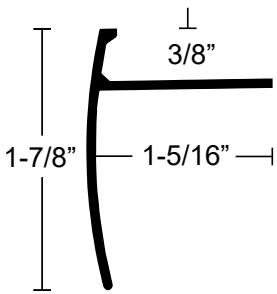

3/8" STAIR NOSING

ITEM	ITEM DESCRIPTION	NAILS INCL.	LENGTH	QTY	WEIGHT
415351	EdgeTek TSN 38 EA	NO	98.5"	12	25
415335	EdgeTek TSN 38 EN	NO	98.5"	12	25

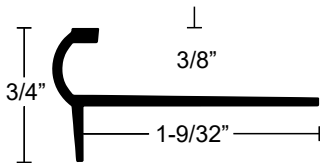

3/8" STAIR NOSING

ITEM	ITEM DESCRIPTION	NAILS INCL.	LENGTH	QTY	WEIGHT
415347	EdgeTek SE 38 EA	NO	98.5"	12	15
415345	EdgeTek SE 38 EN	NO	98.5"	12	15

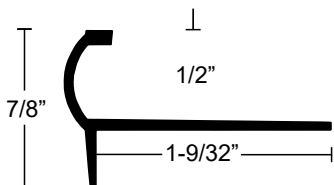

1/2" STAIR NOSING

ITEM	ITEM DESCRIPTION	NAILS INCL.	LENGTH	QTY	WEIGHT
415349	EdgeTek SE 12 EA	NO	98.5"	12	16



STEP NOSING

- Profile primarily used on stair edges or counter tops
- Allows for straight edge grout line.

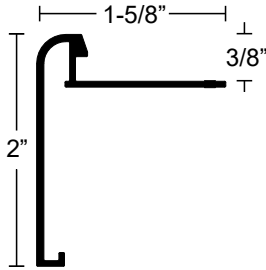

3/8" EDGETEK STEP

ITEM	ITEM DESCRIPTION	NAILS INCL.	LENGTH	QTY	WEIGHT
415310	EdgeTek Step 38 EA	NO	98.5"	12	29
415330	EdgeTek Step 38 EBRZ	NO	98.5"	12	29



T-SEAM BINDER

- Transitions between 2 ceramic pieces of equal height.
- Prevents tile from chipping and cracking.

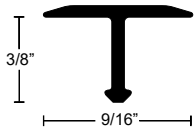

9/16" T-SEAM BINDER

ITEM	ITEM DESCRIPTION	NAILS INCL.	LENGTH	QTY	WEIGHT
415241	EdgeTek T 916 EA	NO	98.5"	12	12

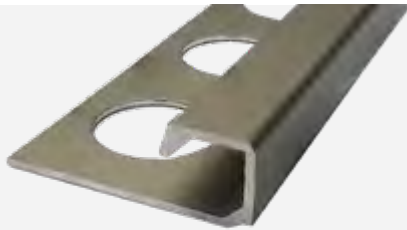

SQUARE CORNER

- Edge protecting profile for outside corner walls of tiled edges.
- Allows for straight edge grout line.

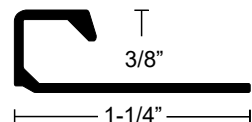

3/8" EDGETEK SQUARE CORNER

ITEM	ITEM DESCRIPTION	NAILS INCL.	LENGTH	QTY	WEIGHT
415306	EdgeTek Q 38 EA	NO	98.5"	12	15
415242	EdgeTek Q 38 EA	NO	98.5"	12	15
415309	EdgeTek Q 38 POLALM	NO	98.5"	12	15

SPECIALTY MOULDINGS

Versatile finish pieces that add a high end look to both residential and commercial spaces.



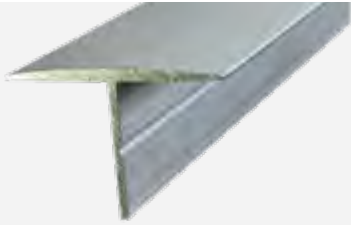

TEE MOULDING METAL

- Versatile metal used for various applications from flooring to door edging.
- Known as Trapdoor Metal.

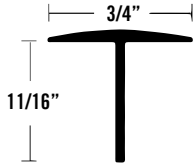

3/4" TEE MOULDING

ITEM	ITEM DESCRIPTION	LENGTH	QTY	WEIGHT
333600	7365 BA	12'	12	16
404160	7365 BB	12'	12	16

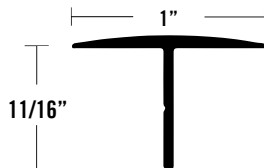

1" TEE MOULDING

ITEM	ITEM DESCRIPTION	LENGTH	QTY	WEIGHT
333692	7395 EA	12'	12	20
333690	7395 BA	12'	12	20
333691	7365 BB	12'	12	20



COUNTER TOP & WALLBOARD CAPS

- Caps or J-bar metal can be used as a decorative edging for a variety of panels that vary in thickness.

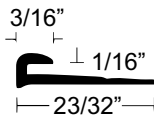

1/16" CAP

ITEM	ITEM DESCRIPTION	LENGTH	QTY	WEIGHT
410800	TM 80 MFA	12'	40	24

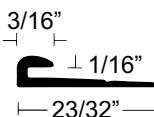

1/16" FLAT BACK CAP

ITEM	ITEM DESCRIPTION	LENGTH	QTY	WEIGHT
410805	TM 81 MFA	12'	40	26

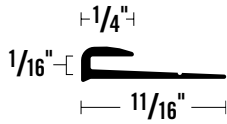

1/16" DEEP SLOT CAP

ITEM	ITEM DESCRIPTION	LENGTH	QTY	WEIGHT
410820	TM 84 MFA	12'	40	26

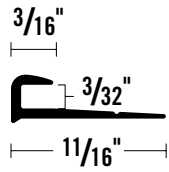

3/32" CAP

ITEM	ITEM DESCRIPTION	LENGTH	QTY	WEIGHT
410815	TM 83 MFA	12'	40	26

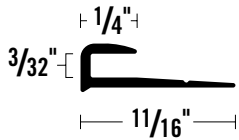

3/32" WIDE FACE CAP

ITEM	ITEM DESCRIPTION	LENGTH	QTY	WEIGHT
410810	TM 82 MFA	12'	40	28
410811	TM 82 MFB	12'	40	28

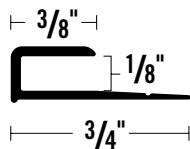

1/8" CAP

ITEM	ITEM DESCRIPTION	LENGTH	QTY	WEIGHT
442086	WB 104 EA	8'	150	84
442085	WB 104 BA	8'	150	84

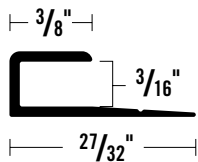

3/16" CAP

ITEM	ITEM DESCRIPTION	LENGTH	QTY	WEIGHT
410720	TM 72 BA	8'	60	28

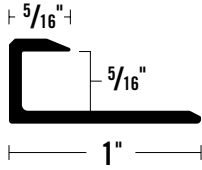

5/16" CAP

ITEM	ITEM DESCRIPTION	LENGTH	QTY	WEIGHT
350018	7358 BBDA	12'	12	18

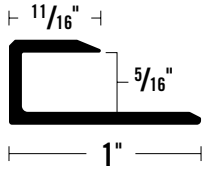

5/16" WIDE FACE CAP

ITEM	ITEM DESCRIPTION	LENGTH	QTY	WEIGHT
350017	7359 BBDA	12'	12	18

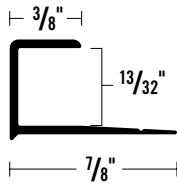

13/32" CAP

ITEM	ITEM DESCRIPTION	LENGTH	QTY	WEIGHT
334190	7524 BA	12'	12	18



COUNTER TOP & WALLBOARD COVES

- Coves are applied to a corner when a radius is required on counter tops, wall base, or back splashes.

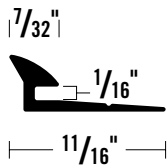

1/16" CAP

ITEM	ITEM DESCRIPTION	LENGTH	QTY	WEIGHT
410905	TM 91 MFA	12'	40	30
410906	TM 91 MFB	12'	40	30

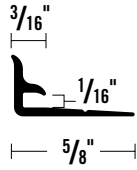

1/16" COVE

ITEM	ITEM DESCRIPTION	LENGTH	QTY	WEIGHT
410910	TM 92 MFA	12'	40	24
410911	TM 92 MFB	12'	40	24

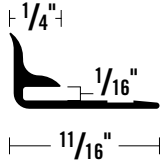

1/16" COVE

ITEM	ITEM DESCRIPTION	LENGTH	QTY	WEIGHT
410935	TM 98 MFA	12'	40	35

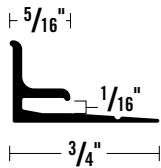

1/16" COVE

ITEM	ITEM DESCRIPTION	LENGTH	QTY	WEIGHT
410900	TM 90 MFA	12'	40	44

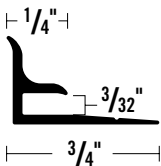

3/32" COVE

ITEM	ITEM DESCRIPTION	LENGTH	QTY	WEIGHT
410585	TM 85 MFA	12'	40	41
410588	TM 85 MFB	12'	40	41

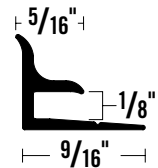

1/8" COVE

ITEM	ITEM DESCRIPTION	LENGTH	QTY	WEIGHT
410590	TM 87 EN	12'	24	20

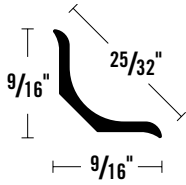

25/32" OFFSET DRILL COVE

ITEM	ITEM DESCRIPTION	LENGTH	QTY	WEIGHT
410520	TM 52 BA	12'	40	37

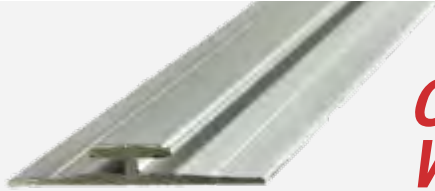

COUNTER TOP & WALLBOARD DIVIDERS

- Aluminum dividers as used to join wall, ceiling or floor panels together.

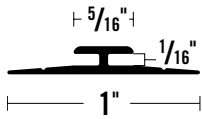

1/16" DIVIDER

ITEM	ITEM DESCRIPTION	LENGTH	QTY	WEIGHT
410920	TM 94 BA	12'	40	36

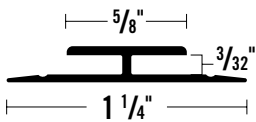

3/32" DIVIDER

ITEM	ITEM DESCRIPTION	LENGTH	QTY	WEIGHT
442057	WB 110 EA	8'	50	44

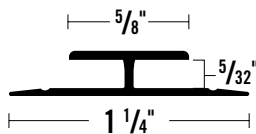

5/32" DIVIDER

ITEM	ITEM DESCRIPTION	LENGTH	QTY	WEIGHT
442050	WB 103 BA	8'	100	66

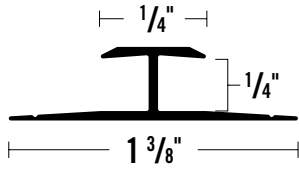

1/4" DIVISION

ITEM	ITEM DESCRIPTION	LENGTH	QTY	WEIGHT
443010	WB 303 BA	8'	100	85



COUNTER TOP & WALLBOARD OUTSIDE CORNER

- Outside corners can be used with woodworking or finished ceramic edges with a modern sleek look.

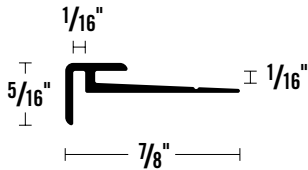

1/16" OUTSIDE CORNER

ITEM	ITEM DESCRIPTION	LENGTH	QTY	WEIGHT
410915	TM 93 BA	12'	40	41



FACING

- Face nosing is used in a wide range of applications from table, counter tops, shelves, or stair tread guarding.

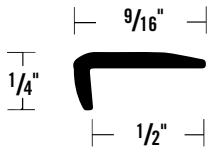

1/2" PLAIN FACING

ITEM	ITEM DESCRIPTION	LENGTH	QTY	WEIGHT
410195	TM 19 BA	12'	40	26
410196	TM 19 BN	12'	24	17
419933	TM 19 BB	12'	40	26

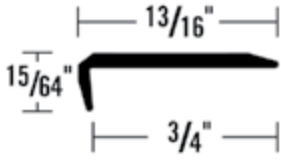

3/4" PLAIN FACING

ITEM	ITEM DESCRIPTION	LENGTH	QTY	WEIGHT
410210	TM 21 BMA	12'	40	34

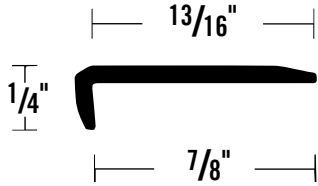

7/8" PLAIN FACING

ITEM	ITEM DESCRIPTION	LENGTH	QTY	WEIGHT
410230	TM 23 BMA	12'	40	45

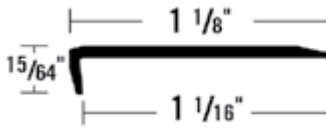

1 1/16" PLAIN FACING

ITEM	ITEM DESCRIPTION	LENGTH	QTY	WEIGHT
410250	TM 25 BA	12'	40	46

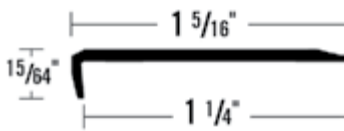

1 1/4" PLAIN FACING

ITEM	ITEM DESCRIPTION	LENGTH	QTY	WEIGHT
410240	TM 24 BA	12'	40	53

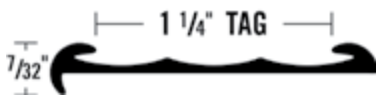

1 1/4" PRICE TAG CONVENTIONAL MOULDING

ITEM	ITEM DESCRIPTION	LENGTH	QTY	WEIGHT
331940	0569 BA	12'	12	16

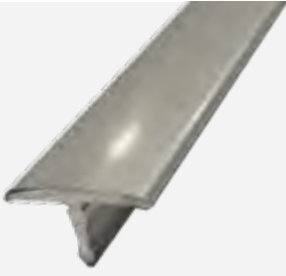

INSERT "T"

- Used for store fixtures, displays and ceramic finishes.
- Can also be used as a ceramic trim to prevent tile edges from chipping or cracking.

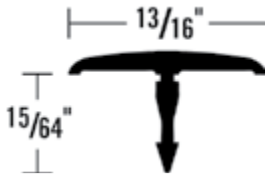

13/16" INSERT OVAL TEE

ITEM	ITEM DESCRIPTION	LENGTH	QTY	WEIGHT
335916	0923 EA	12'	12	17

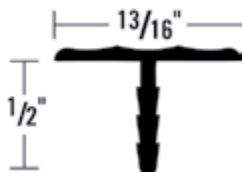

13/16" PALISADE INSERT TEE

ITEM	ITEM DESCRIPTION	LENGTH	QTY	WEIGHT
350027	7364 EA	12'	12	16

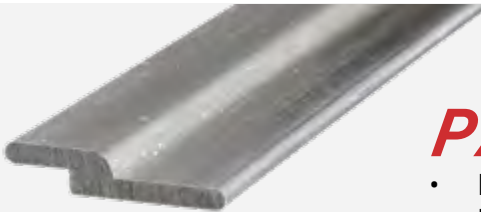

PANEL HANGER

- Ideal for hanging wall panels, frames, or cabinets.
- Easy to install and provides a strong hold



PANEL HANGER

ITEM	ITEM DESCRIPTION	LENGTH	QTY	WEIGHT
350072	7389 MF	12'	12	32



SLATWALL PANEL

- Commercial or residential use for displaying or organizing a variety of tools and merchandise.
- Utilizes hooks that allows easy and quick storage options.

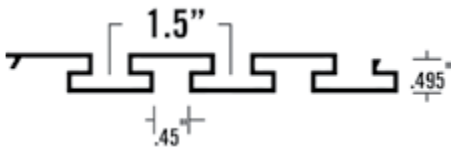

SLATWALL PANEL

ITEM	ITEM DESCRIPTION	LENGTH	QTY	WEIGHT
599900	7584 MF	12'	1	9

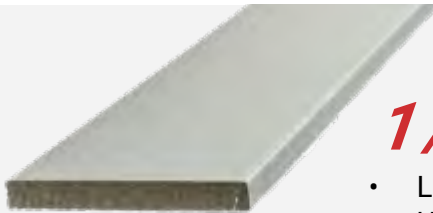

1/8" FLAT BAR

- Light weight and used for many different fabrication applications.
- Used for framework, braces, supports, and trims

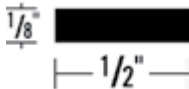

1/2" x 1/8" FLATBAR

ITEM	ITEM DESCRIPTION	LENGTH	QTY	WEIGHT
300030	1005 EA	12'	6	8

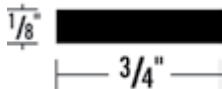

3/4" x 1/8" FLATBAR

ITEM	ITEM DESCRIPTION	LENGTH	QTY	WEIGHT
300220	1048 EA	12'	6	11
300225	1048 MF	12'	50	71

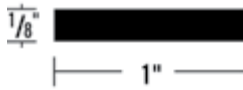

1" x 1/8" FLATBAR

ITEM	ITEM DESCRIPTION	LENGTH	QTY	WEIGHT
300020	1004 EA	12'	6	14

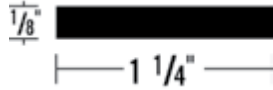

1 1/4" x 1/8" FLATBAR

ITEM	ITEM DESCRIPTION	LENGTH	QTY	WEIGHT
300306	1068 EA	12'	6	17

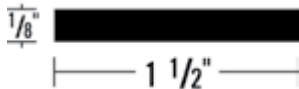

1 1/2" x 1/8" FLATBAR

ITEM	ITEM DESCRIPTION	LENGTH	QTY	WEIGHT
300228	1049 EA	12'	6	19

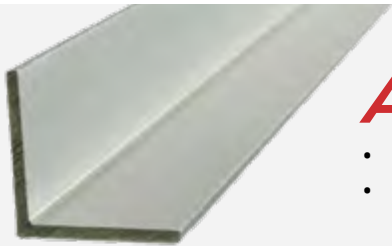

ANGLE

- Angles come in a variety of different sizes for all applications.
- Used for constructing frames, bases, table tops, and counter top edging
- Applications range from decorative moldings, trims, and corners.

1/16" ANGLE

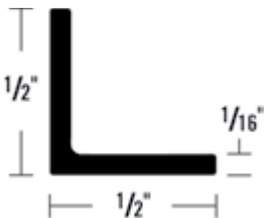

1/2" EQUAL ANGLE

ITEM	ITEM DESCRIPTION	LENGTH	QTY	WEIGHT
276001	3141 EA	8'	6	6
306001	3141 EA	12'	6	8

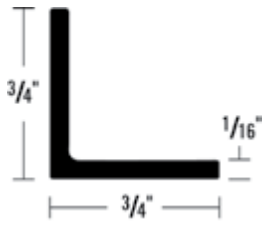

3/4" EQUAL ANGLE

ITEM	ITEM DESCRIPTION	LENGTH	QTY	WEIGHT
276051	0151 EA	8'	6	8
306051	0151 EA	12'	6	11

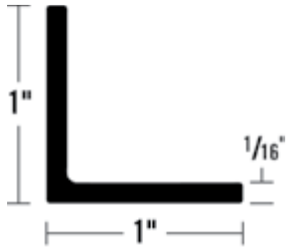

1" EQUAL ANGLE

ITEM	ITEM DESCRIPTION	LENGTH	QTY	WEIGHT
276101	1061 EA	8'	6	13
306101	1061 EA	12'	6	13

3/32" ANGLE



3/4" x 3/8" ANGLE

ITEM	ITEM DESCRIPTION	LENGTH	QTY	WEIGHT
302651	1750 EA	12'	6	11



3/4" x 1/2" ANGLE

ITEM	ITEM DESCRIPTION	LENGTH	QTY	WEIGHT
300651	1225 EA	12'	6	8

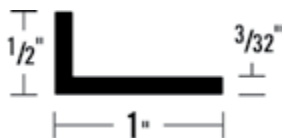

1" x 1/2" ANGLE

ITEM	ITEM DESCRIPTION	LENGTH	QTY	WEIGHT
300158	1033 EA	12'	6	14

1/8" ANGLE



3/4" EQUAL ANGLE

ITEM	ITEM DESCRIPTION	LENGTH	QTY	WEIGHT
300083	1017 EA	12'	6	18



1" EQUAL ANGLE

ITEM	ITEM DESCRIPTION	LENGTH	QTY	WEIGHT
300091	1018 EA	12'	6	23
350053	1018 MF	12'	6	23

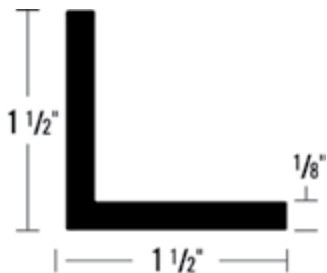

1 1/2" EQUAL ANGLE

ITEM	ITEM DESCRIPTION	LENGTH	QTY	WEIGHT
300110	1022 EA	12'	6	34

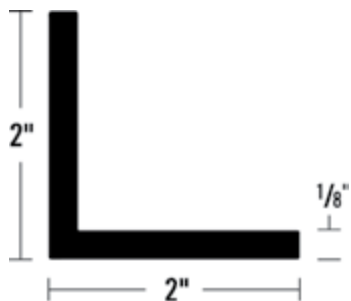

2" EQUAL ANGLE

ITEM	ITEM DESCRIPTION	LENGTH	QTY	WEIGHT
300450	1137 EA	12'	6	45

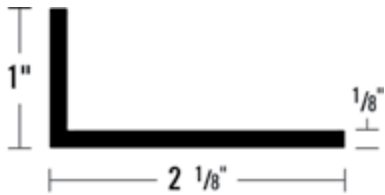

2 1/8" X 1" ANGLE

ITEM	ITEM DESCRIPTION	LENGTH	QTY	WEIGHT
300751	1249 EA	12'	6	35

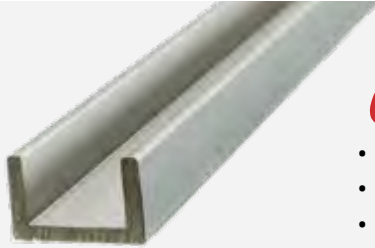

CHANNEL

- Channels come in a variety of different sizes for all applications.
- Channels are perfect for framing and protecting edges.
- Store display, fixtures, glass and window applications.

1/4" CHANNEL

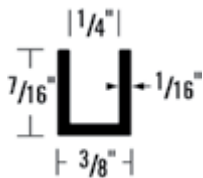

7/16" X 1/4" CHANNEL

ITEM	ITEM DESCRIPTION	LENGTH	QTY	WEIGHT
301151	1347 EA	12'	6	9



13/16" X 1/4" CHANNEL

ITEM	ITEM DESCRIPTION	LENGTH	QTY	WEIGHT
304001	2223 EA	12'	6	13

5/16" CHANNEL

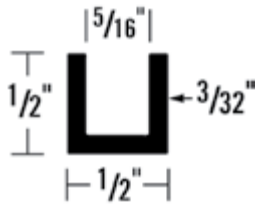

1/2" X 5/16" CHANNEL

ITEM	ITEM DESCRIPTION	LENGTH	QTY	WEIGHT
300178	1038 EA	12'	6	14

3/8" CHANNEL

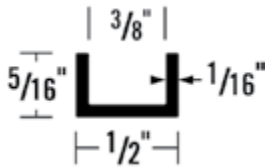

5/16" X 3/8" CHANNEL

ITEM	ITEM DESCRIPTION	LENGTH	QTY	WEIGHT
300895	1285 EA	12'	6	8

1/2" CHANNEL

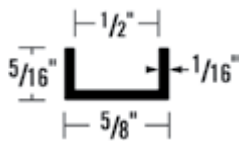

5/16" X 1/2" CHANNEL

ITEM	ITEM DESCRIPTION	LENGTH	QTY	WEIGHT
301201	1362 EA	12'	6	9

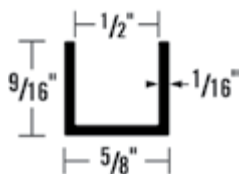

9/16" X 1/2" CHANNEL

ITEM	ITEM DESCRIPTION	LENGTH	QTY	WEIGHT
301143	1346 EA	12'	6	12

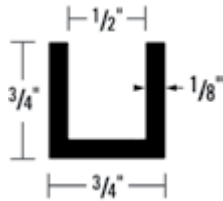

3/4" X 1/2" CHANNEL

ITEM	ITEM DESCRIPTION	LENGTH	QTY	WEIGHT
301901	1538 EA	12'	6	25

5/8" CHANNEL

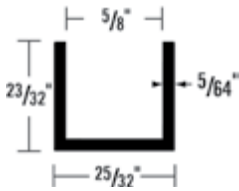

23/32" X 5/8" CHANNEL

ITEM	ITEM DESCRIPTION	LENGTH	QTY	WEIGHT
301139	1345 EA	12'	6	17

3/4" CHANNEL

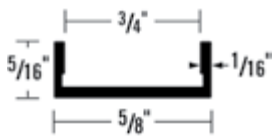

5/16" X 3/4" CHANNEL

ITEM	ITEM DESCRIPTION	LENGTH	QTY	WEIGHT
303751	2161 EA	12'	6	10

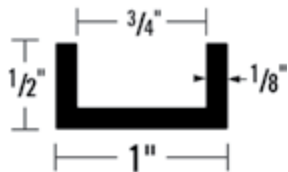

1/2" X 3/4" CHANNEL

ITEM	ITEM DESCRIPTION	LENGTH	QTY	WEIGHT
300187	1040 EA	12'	6	22

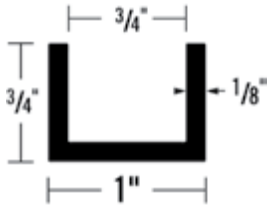

3/4" X 3/4" CHANNEL

ITEM	ITEM DESCRIPTION	LENGTH	QTY	WEIGHT
302501	1710 EA	12'	6	27

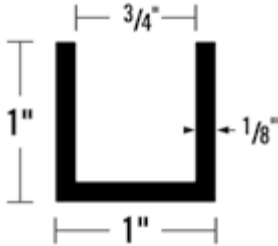

1" X 3/4" CHANNEL

ITEM	ITEM DESCRIPTION	LENGTH	QTY	WEIGHT
300191	1041 EA	12'	6	33

7/8" CHANNELS

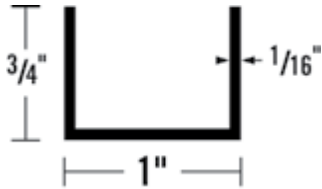

1" X 3/4" TOP CHANNEL

ITEM	ITEM DESCRIPTION	LENGTH	QTY	WEIGHT
350042	7347 EA	12'	6	16

VINYL TRIMS

Reducers, Joiners, Cove, Stair nosing and Snap-in dividers.

A durable, flexible product with a tough matte finish.



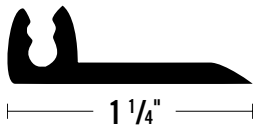

SINGLE FLANGE TRACK

ITEM	ITEM DESCRIPTION	LENGTH	QTY	WEIGHT
460530	VT 253 WHITE	12'	20	20

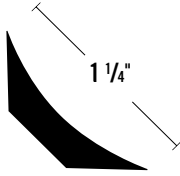

1 1/4" COVE STICK

ITEM	ITEM DESCRIPTION	LENGTH	QTY	WEIGHT
460170	VT 051	5'	100	26

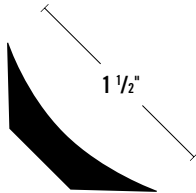

1 1/2" COVE STICK

ITEM	ITEM DESCRIPTION	LENGTH	QTY	WEIGHT
460175	VT 052	5'	100	28



REDUCER FOR GLUE-DOWN CARPET

ITEM	ITEM DESCRIPTION	LENGTH	QTY	WEIGHT
460200	VT 320 BLACK	12'	20	24
460201	VT 320 BROWN	12'	20	24
460202	VT 320 GRAY	12'	20	24
460203	VT 320 BEIGE	12'	20	24

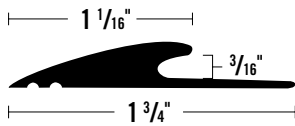

REDUCER FOR GLUE-DOWN CARPET

ITEM	ITEM DESCRIPTION	LENGTH	QTY	WEIGHT
460330	VT 333 Black	12'	20	26
460331	VT 333 Brown	12'	20	26

► For 3/16" carpet

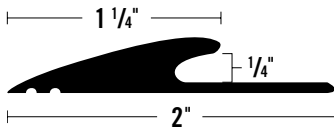

REDUCER FOR GLUE-DOWN CARPET

ITEM	ITEM DESCRIPTION	LENGTH	QTY	WEIGHT
460320	VT 332 BLACK	12'	20	31
460321	VT 332 BROWN	12'	20	31
460322	VT 332 GRAY	12'	20	31
460323	VT 332 BEIGE	12'	20	31

► For 1/4" carpet

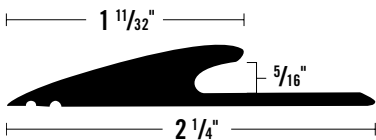

REDUCER FOR GLUE-DOWN CARPET

ITEM	ITEM DESCRIPTION	LENGTH	QTY	WEIGHT
460310	VT 331 BLACK	12'	20	42
460311	VT 331 BROWN	12'	20	42
460312	VT 331 GRAY	12'	20	42
460313	VT 331 BEIGE	12'	20	42

► For 5/16" carpet



TILE REDUCER FOR RESILIENT FLOORS

ITEM	ITEM DESCRIPTION	LENGTH	QTY	WEIGHT
460240	VT 324 BLACK	3'	50	8
460241	VT 324 BROWN	3'	50	8
460242	VT 324 GRAY	3'	50	8
460243	VT 324 BEIGE	3'	50	8



TILE REDUCER FOR RESILIENT FLOORS

ITEM	ITEM DESCRIPTION	LENGTH	QTY	WEIGHT
460250	VT 325 BLACK	3'	50	17
460251	VT 325 BROWN	3'	50	17
460252	VT 325 GRAY	3'	50	17
460253	VT 325 BEIGE	3'	50	17

► With beveled edge for resilient floors

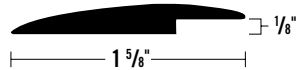

OVER THE TOP RESILIENT REDUCER

ITEM	ITEM DESCRIPTION	LENGTH	QTY	WEIGHT
460260	VT 326 BLACK	12'	20	28
460261	VT 326 BROWN	12'	20	28
460263	VT 326 GRAY	12'	20	28
460262	VT 326 BEIGE	12'	20	28

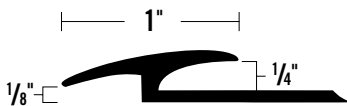

TILE AND CARPET JOINER

ITEM	ITEM DESCRIPTION	LENGTH	QTY	WEIGHT
460540	VT 754 BLACK	12'	20	28
460541	VT 754 BROWN	12'	20	28
460542	VT 754 GRAY	12'	20	28
460543	VT 754 BEIGE	12'	20	28

► For 1/4" tile or carpet

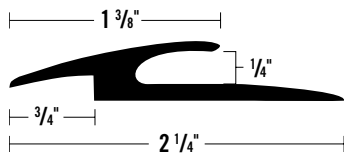

TILE AND CARPET JOINER

ITEM	ITEM DESCRIPTION	LENGTH	QTY	WEIGHT
460550	VT 756 BLACK	12'	20	26
460551	VT 756 BROWN	12'	20	26
460552	VT 756 GRAY	12'	20	26
460553	VT 756 BEIGE	12'	20	26

► For 1/4" tile or carpet

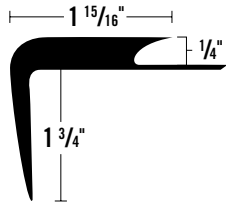

STAIR NOSING

ITEM	ITEM DESCRIPTION	LENGTH	QTY	WEIGHT
460400	VT 640 BLACK	12'	6	43
460401	VT 640 BROWN	12'	6	43
460402	VT 640 GRAY	12'	6	43

► Heavy duty stair nosing

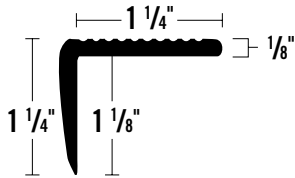

STAIR NOSING

ITEM	ITEM DESCRIPTION	LENGTH	QTY	WEIGHT
460420	VT 642 BLACK	12'	12	23
460421	VT 642 BROWN	12'	12	23
460422	VT 642 GRAY	12'	12	23
460423	VT 642 BEIGE	12'	12	23

► Square top nosing

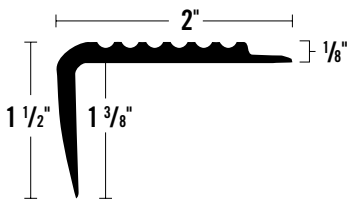

STAIR NOSING

ITEM	ITEM DESCRIPTION	LENGTH	QTY	WEIGHT
460410	VT 641 BLACK	12'	12	42
460411	VT 641 BROWN	12'	12	42
460412	VT 641 GRAY	12'	12	42
460414	VT 641 BEIGE	12'	12	42

► Commercial stair nosing

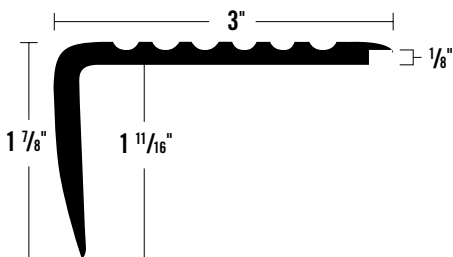

STAIR NOSING

ITEM	ITEM DESCRIPTION	LENGTH	QTY	WEIGHT
460440	VT 644 BLACK	12'	12	78
460441	VT 644 BROWN	12'	12	78
460442	VT 644 GRAY	12'	12	78
460444	VT 644 BEIGE	12'	12	78

► Overlap nosing for tile and resilient

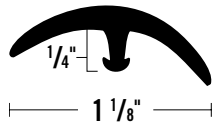

SNAP-IN DIVIDERS AND EDGES

ITEM	ITEM DESCRIPTION	LENGTH	QTY	WEIGHT
460040	VT 704 BLACK	12'	20	21
460041	VT 704 BROWN	12'	20	21
460042	VT 704 GRAY	12'	20	21
460044	VT 704 BEIGE	12'	20	21

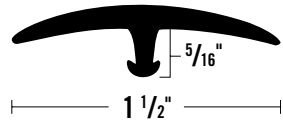

SNAP-IN DIVIDERS AND EDGES

ITEM	ITEM DESCRIPTION	LENGTH	QTY	WEIGHT
460030	VT 703 BLACK	12'	20	27
460031	VT 703 BROWN	12'	20	27
460032	VT 703 GRAY	12'	20	27
460034	VT 703 BEIGE	12'	20	27

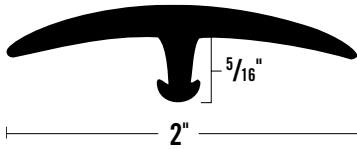

SNAP-IN DIVIDERS AND EDGES

ITEM	ITEM DESCRIPTION	LENGTH	QTY	WEIGHT
460057	VT 706 BLACK	12'	20	29
460058	VT 706 BROWN	12'	20	29
460059	VT 706 GRAY	12'	20	29
460060	VT 706 BEIGE	12'	20	29



SNAP-IN DIVIDERS AND EDGES

ITEM	ITEM DESCRIPTION	LENGTH	QTY	WEIGHT
460050	VT 705 BLACK	12'	20	28
460051	VT 705 BROWN	12'	20	28
460052	VT 705 GRAY	12'	20	28
460054	VT 705 BEIGE	12'	20	28

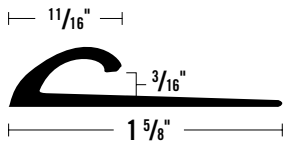

CARPET COVING CAP

ITEM	ITEM DESCRIPTION	LENGTH	QTY	WEIGHT
460100	VT 410 BLACK	12'	20	22
460101	VT 410 BROWN	12'	20	22
460102	VT 410 GRAY	12'	20	22
460103	VT 410 BEIGE	12'	20	22

► Flexible carpet cove cap

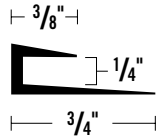

CARPET COVING CAP

ITEM	ITEM DESCRIPTION	LENGTH	QTY	WEIGHT
460160	VT 416 BLACK	12'	50	32
460162	VT 416 GRAY	12'	50	32
460163	VT 416 BEIGE	12'	50	32

POWERHOLD TROWELS

Carpet. Ceramic. Wood. Vinyl.

PREMIUM TROWEL FEATURES

- Over 30 notch types available (U notch, V notch, square notch and smooth.)
- Comfortable TPR grip handle.
- Hardened and tempered steel blade.
- Balanced for professional use.



TROWEL SPECS

POWERHOLD PREMIUM TROWELS

ITEM	ITEM DESCRIPTION	
020014	PWR14 - 4.5x11" 1/16x1/32x5/64 U*	12
020015	PWR15 - 4.5x11" 1/4x1/8x1/4 SQ*	12
020016	PWR16 - 4.5x11" 3/16x1/4x1/2 V*	12
020017	PWR17 - 4.5x14" 1/16x1/32x1/32 U*	12
020018	PWR18 - 4.5x14" 1/16x1/16x1/16 SQ*	12
020019	PWR19 - 4.5x14 1/8x1/8x1/16 V*	12
020093	PWR93 4x16" Pool Finishing*	12
020001	PWR1 - 4.5x11" 1/16x1/32x1/32 U*	12
020023	PWR23 4.5x11" 1/16x1/16x3/32 U*	12
020002	PWR2 - 4.5x11" 1/8x1/8x1/16 U*	12
020004	PWR4 - 4.5x11" 1/8x3/16x1/8 U*	12
020003	PWR3 - 4.5x11" 1/8x1/8x1/8 U*	12
020005	PWR5 - 4.5x11" 1/16x1/16x1/16 SQ*	12
020024	PWR24 - 4.5x11" 1/8x1/8x1/8 SQ*	12
020025	PWR25 - 4.5x11" 3/16x3/16x3/16 SQ*	12
020009	PWR9 - 4.5x11" 3/16x5/32 V*	12
020011	PWR11 - 4.5x11" 3/32x3/32x3/32 V*	12
020012	PWR12 - 4.5x11" 1/8x1/8x1/16 V*	12
020013	PWR13 - 4x14" Flat Finishing	12
020028	PWR28 - LH 4.5x11" 1/16x1/32x1/32 U*	12
020021	PWR21 LH 4-5x11" 1/16x1/16x1/16 SQ*	12
020022	PWR22 - LH 4.5x11" 1/8x1/8x1/16 V*	12
020029	PWR29 - 4.5x11" 1/16x1/16x1/16 V*	6
020026	PWR26 - 4.5x11" 3/16x1/4x5/16 V*	12
030005	Non Brand - 4.5x11" 1/8x1/8x1/8 V*	12
020008	PWR8 - 4.5x11" 1/2x1/2x1/2 SQ*	12
020006	PWR6 - 4.5x11" 1/4x1/4x1/4 SQ*	12
020007	PWR7 - 4.5x11" 1/4x3/8x1/4 SQ*	12
020010	PWR10 - 4.5x11" 1/4x3/16 V*	12
049972	Non Brand 4.5x11" 1/4x1/4 V*	6
ITEM	ITEM DESCRIPTION	
020063	ECONO TRWL 4x9" 1/16x1/32x1/32 U*	12
020064	ECONO TRWL 4x9" 1/16x1/16x1/16 SQ*	12
020065	ECONO TRWL 4x9" 1/8x1/8x1/16 V*	12
030004	ECONO TRWL 4x9" 3/32x3/32x3/32 V*	6

POWERHOLD ECONOMY TROWELS

049100	ECONO TRWL 4x9" 1/4x1/4x1/4 SQ*	12
049102	ECONO TRWL 4x9" 1/4x3/8x1/4 SQ*	12
049104	ECONO TRWL 4x9" 1/2x1/2x1/2 *SQ	12
049108	ECONO TRWL 4x9" 3/16x5/32 V*	12



PREMIUM TROWELS

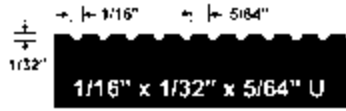

ITEM	NOTCH DESCRIPTION	NOTCH STYLE	BLADE SIZE	BLADE ANGLE	CASE QTY
20014	1/16" x 1/32" x 5/64"	U NOTCH	4-1/2 x 11	15°	6

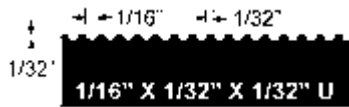

ITEM	NOTCH DESCRIPTION	NOTCH STYLE	BLADE SIZE	BLADE ANGLE	CASE QTY
20001	1/16" x 1/32" x 1/32"	U NOTCH	4-1/2 x 11	15°	6
20028	1/16" x 1/32" x 1/32" LEFT HANDED	U NOTCH	4-1/2 x 11	15°	6
20017	1/16" x 1/32" x 1/32"	U NOTCH	4-1/2 x 14	15°	6

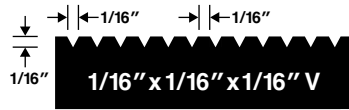

ITEM	NOTCH DESCRIPTION	NOTCH STYLE	BLADE SIZE	BLADE ANGLE	CASE QTY
20029	1/16" x 1/16" x 1/16"	FLAT V NOTCH	4-1/2 x 11	15°	6

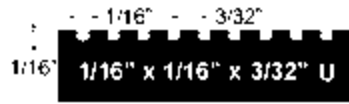

ITEM	NOTCH DESCRIPTION	NOTCH STYLE	BLADE SIZE	BLADE ANGLE	CASE QTY
20023	1/16" x 1/16" x 3/32"	U NOTCH	4-1/2 x 11	15°	6



ITEM	NOTCH DESCRIPTION	NOTCH STYLE	BLADE SIZE	BLADE ANGLE	CASE QTY
20002	1/8" x 1/8" x 1/16"	U NOTCH	4-1/2 x 11	15°	6

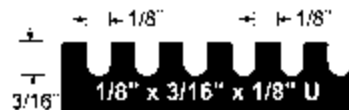

ITEM	NOTCH DESCRIPTION	NOTCH STYLE	BLADE SIZE	BLADE ANGLE	CASE QTY
20004	1/8" x 3/16" x 1/8"	U NOTCH	4-1/2 x 11	15°	6

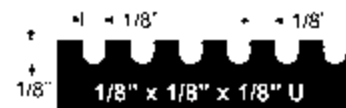

ITEM	NOTCH DESCRIPTION	NOTCH STYLE	BLADE SIZE	BLADE ANGLE	CASE QTY
20003	1/8" x 1/8" x 1/8"	U NOTCH	4-1/2 x 11	15°	6



ITEM	NOTCH DESCRIPTION	NOTCH STYLE	BLADE SIZE	BLADE ANGLE	CASE QTY
20005	1/16" x 1/16" x 1/16"	SQUARE NOTCH	4-1/2 x 11	15°	6
20021	1/16" x 1/16" x 1/16" LEFT HANDED	SQUARE NOTCH	4-1/2 x 11	15°	6
20018	1/16" x 1/16" x 1/16"	SQUARE NOTCH	4-1/2 x 14	15°	6

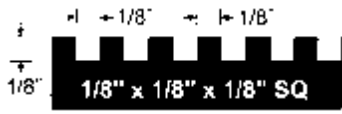

ITEM	NOTCH DESCRIPTION	NOTCH STYLE	BLADE SIZE	BLADE ANGLE	CASE QTY
20024	1/8" x 1/8" x 1/8"	SQUARE NOTCH	4-1/2 x 11	SQUARE	6

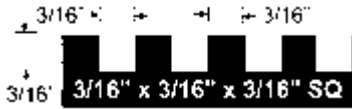

ITEM	NOTCH DESCRIPTION	NOTCH STYLE	BLADE SIZE	BLADE ANGLE	CASE QTY
20025	3/16" x 3/16" x 3/16"	SQUARE NOTCH	4-1/2 x 11	SQUARE	6

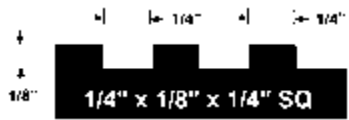

ITEM	NOTCH DESCRIPTION	NOTCH STYLE	BLADE SIZE	BLADE ANGLE	CASE QTY
20015	1/4" x 1/8" x 1/4"	SQUARE NOTCH	4-1/2 x 11	SQUARE	6



ITEM	NOTCH DESCRIPTION	NOTCH STYLE	BLADE SIZE	BLADE ANGLE	CASE QTY
20006	1/4" x 1/4" x 1/4"	SQUARE NOTCH	4-1/2 x 11	SQUARE	6

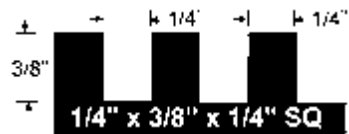

ITEM	NOTCH DESCRIPTION	NOTCH STYLE	BLADE SIZE	BLADE ANGLE	CASE QTY
20007	1/4" x 3/8" x 1/4"	SQUARE NOTCH	4-1/2 x 11	SQUARE	6



ITEM	NOTCH DESCRIPTION	NOTCH STYLE	BLADE SIZE	BLADE ANGLE	CASE QTY
20008	1/2" x 1/2" x 1/2"	SQUARE NOTCH	4-1/2 x 11	SQUARE	6



ITEM	NOTCH DESCRIPTION	NOTCH STYLE	BLADE SIZE	BLADE ANGLE	CASE QTY
30005	1/8" x 1/8" x 1/8"	V NOTCH	4-1/2 x 11	SQUARE	6



ITEM	NOTCH DESCRIPTION	NOTCH STYLE	BLADE SIZE	BLADE ANGLE	CASE QTY
20009	3/16" x 5/32"	V NOTCH	4-1/2 x 11	SQUARE	6



ITEM	NOTCH DESCRIPTION	NOTCH STYLE	BLADE SIZE	BLADE ANGLE	CASE QTY
20010	1/4" x 3/16"	V NOTCH	4-1/2 x 11	SQUARE	6

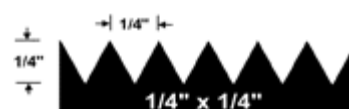

ITEM	NOTCH DESCRIPTION	NOTCH STYLE	BLADE SIZE	BLADE ANGLE	CASE QTY
49972	1/4" x 1/4"	V NOTCH	4-1/2 x 11	SQUARE	6

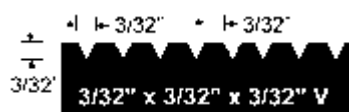

ITEM	NOTCH DESCRIPTION	NOTCH STYLE	BLADE SIZE	BLADE ANGLE	CASE QTY
20011	3/32" x 3/32" x 3/32"	FLAT V NOTCH	4-1/2 x 11	15°	6

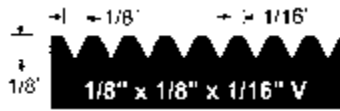

ITEM	NOTCH DESCRIPTION	NOTCH STYLE	BLADE SIZE	BLADE ANGLE	CASE QTY
20012	1/8" x 1/8" x 1/16"	FLAT V NOTCH	4-1/2 x 11	15°	6
20022	1/8" x 1/8" x 1/16" LEFT HANDED	FLAT V NOTCH	4-1/2 x 11	15°	6
20019	1/8" x 1/8" x 1/16"	FLAT V NOTCH	4-1/2 x 14	15°	6



ITEM	NOTCH DESCRIPTION	NOTCH STYLE	BLADE SIZE	BLADE ANGLE	CASE QTY
20026	3/16" x 1/4" x 5/16"	FLAT V NOTCH	4-1/2 x 11	SQUARE	6

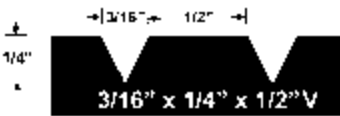

ITEM	NOTCH DESCRIPTION	NOTCH STYLE	BLADE SIZE	BLADE ANGLE	CASE QTY
20016	3/16" x 1/4" x 1/2"	FLAT V NOTCH	4-1/2 x 11	SQUARE	6



ITEM	NOTCH DESCRIPTION	NOTCH STYLE	BLADE SIZE	BLADE ANGLE	CASE QTY
20013	FLAT SMOOTHING	FLAT SMOOTHING	4 x 14	SQUARE	6



ITEM	NOTCH DESCRIPTION	NOTCH STYLE	BLADE SIZE	BLADE ANGLE	CASE QTY
20093	FLAT POOL	FLAT POOL SMOOTHING	4 x 16	ROUND	6



ECONOMY TROWELS

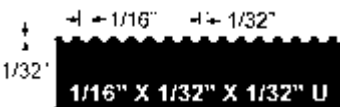

ITEM	NOTCH DESCRIPTION	NOTCH STYLE	BLADE SIZE	BLADE ANGLE	CASE QTY
20063	1/16" x 1/32" x 1/32"	U NOTCH	4 x 9	SQUARE	12

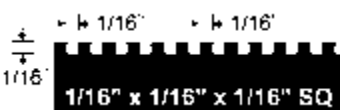

ITEM	NOTCH DESCRIPTION	NOTCH STYLE	BLADE SIZE	BLADE ANGLE	CASE QTY
20064	1/16" x 1/16" x 1/16"	SQUARE NOTCH	4 x 9	SQUARE	12

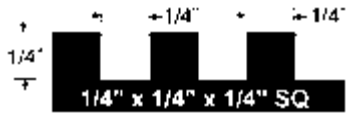

ITEM	NOTCH DESCRIPTION	NOTCH STYLE	BLADE SIZE	BLADE ANGLE	CASE QTY
49100	1/4" x 1/4" x 1/4"	SQUARE NOTCH	4 x 9	SQUARE	12

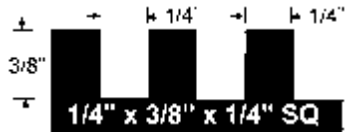

ITEM	NOTCH DESCRIPTION	NOTCH STYLE	BLADE SIZE	BLADE ANGLE	CASE QTY
49102	1/4" x 3/8" x 1/4"	SQUARE NOTCH	4 x 9	SQUARE	12



ITEM	NOTCH DESCRIPTION	NOTCH STYLE	BLADE SIZE	BLADE ANGLE	CASE QTY
49104	1/2" x 1/2" x 1/2"	SQUARE NOTCH	4 x 9	SQUARE	12



ITEM	NOTCH DESCRIPTION	NOTCH STYLE	BLADE SIZE	BLADE ANGLE	CASE QTY
49108	3/16" x 5/32"	V NOTCH	4 x 9	SQUARE	12

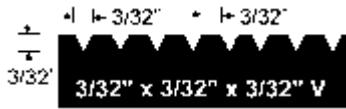

ITEM	NOTCH DESCRIPTION	NOTCH STYLE	BLADE SIZE	BLADE ANGLE	CASE QTY
30004	3/32" x 3/32" x 3/32"	FLAT V NOTCH	4 x 9	SQUARE	12

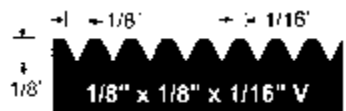

ITEM	NOTCH DESCRIPTION	NOTCH STYLE	BLADE SIZE	BLADE ANGLE	CASE QTY
20065	1/8" x 1/8" x 1/16"	FLAT V NOTCH	4 x 9	SQUARE	12



RUBBER BACKED CARPET

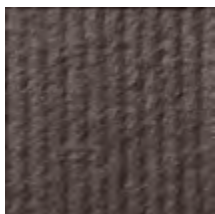

Smooth Back



20011

120-140 Sq. Ft./Gal. (13-16 Sq. Yd.)

Rough Back



20012

90-110 Sq. Ft./Gal. (10-12 Sq. Yd.)

SYNTHETIC WOVEN BACKED CARPET



Action-Bac™



20012

90-110 Sq. Ft./Gal. (10-12 Sq. Yd.)

OR



20003

90-110 Sq. Ft./Gal. (10-12 Sq. Yd.)

NON-WOVEN POLYPROPYLENE & NEEDLE-PUNCHED CARPET



Smooth Back



20011

120-140 Sq. Ft./Gal. (13-16 Sq. Yd.)

Rough Back



20012

90-110 Sq. Ft./Gal. (10-12 Sq. Yd.)

LATEX UNITARY BACKED CARPET

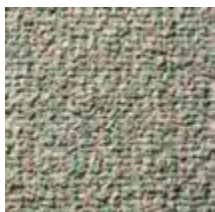

Smooth Back



20012

90-110 Sq. Ft./Gal. (10-12 Sq. Yd.)

Rough Back



20002

55-65 Sq. Ft./Gal. (6-7 Sq. Yd.)

DOUBLE GLUE DOWN PAD TO FLOOR



20005

140-170 Sq. Ft./Gal. (15-19 Sq. Yd.)

Permanent Installation



20011

120-140 Sq. Ft./Gal. (13-16 Sq. Yd.)

DOUBLE GLUE DOWN CARPET TO PAD



Smooth Back



20002

55-65 Sq. Ft./Gal. (6-7 Sq. Yd.)

Rough Back



20004

45-55 Sq. Ft./Gal. (5-6 Sq. Yd.)

HOT MELT BACKED CARPET



20012

OR



20003

90-110 Sq. Ft./Gal. (10-12 Sq. Yd.)

CUSHION BACKED CARPET



Enhancer Plus™



20011

120-140 Sq. Ft./Gal. (13-16 Sq. Yd.)

MODULAR CARPET TILE



20005

140-170 Sq. Ft./Gal. (15-19 Sq. Yd.)

WOVEN CARPET

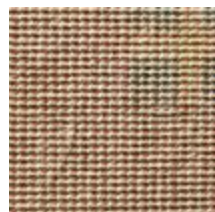

20012



20003

90-110 Sq. Ft./Gal. (10-12 Sq. Yd.)

VINYL SHEET GOODS HOMOGENEOUS VINYL BACKED



20001

Non-Porous Subfloor
200-240 Sq. Ft./Gal. (22-26 Sq. Yd.)



20005

Porous Subfloor
140-170 Sq. Ft./Gal. (15-19 Sq. Yd.)

VINYL COMPOSITION TILE (VCT)

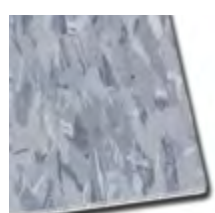

20001

Non-Porous Subfloor
200-240 Sq. Ft./Gal. (22-26 Sq. Yd.)



20005

Porous Subfloor
140-170 Sq. Ft./Gal. (15-19 Sq. Yd.)

VINYL BACKED CARPET

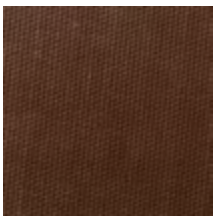

1/16" x 1/16" x 3/32" U **20023**
 Non-Porous Subfloor
 170-200 Sq. Ft./Gal. (19-22 Sq. Yd.)

1/16" x 1/16" x 1/16" SQ **20005**
 Porous Subfloor
 140-170 Sq. Ft./Gal. (15-19 Sq. Yd.)

VINYL TILE / VINYL PLANK



1/16" x 1/16" x 3/32" U **20023**
 Non-Porous Subfloor
 170-200 Sq. Ft./Gal. (19-22 Sq. Yd.)

1/16" x 1/16" x 1/16" SQ **20005**
 Porous Subfloor
 140-170 Sq. Ft./Gal. (15-19 Sq. Yd.)

VINYL SHEET GOODS FELT BACKED

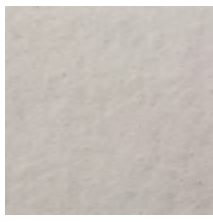

1/16" x 1/16" x 3/32" U **20023**
 Non-Porous Subfloor
 170-200 Sq. Ft./Gal. (19-22 Sq. Yd.)

1/16" x 1/16" x 1/16" SQ **20005**
 Porous Subfloor
 140-170 Sq. Ft./Gal. (15-19 Sq. Yd.)

WOOD PLANK SOLID



3/16" x 3/16" x 3/16" SQ **20025**
 7/16" Thick or Less
 40-45 Sq. Ft./Gal. (4-5 Sq. Yd.)

1/4" x 1/4" x 1/4" SQ **20006**
 1/2" Thick or Greater
 30-35 Sq. Ft./Gal. (3-4 Sq. Yd.)

PRE-FINISHED PARQUET



3/16" x 5/32" V **20009**
 50-60 Sq. Ft./Gal. (5-6 Sq. Yd.)
 OR

1/8" x 1/8" x 1/8" SQ **20024**
 50-60 Sq. Ft./Gal. (5-6 Sq. Yd.)

CERAMIC TILE SMALL TO MEDIUM FORMAT



1/4" x 1/4" x 1/4" SQ **20006**
 Thin-Set Mortar
 70-90 Sq. Ft./50# Bag

ENGINEERED WOOD PLANK



1/4" x 3/16" V **20010**
 1/4"-5/16" Thick
 50-55 Sq. Ft./Gal. (5-6 Sq. Yd.)

3/16" x 3/16" x 3/16" SQ **20025**
 3/8"-9/16" Thick or Less
 40-45 Sq. Ft./Gal. (4-5 Sq. Yd.)

1/4" x 1/4" x 1/4" SQ **20006**
 ≥ 5/8" Thick
 30-35 Sq. Ft./Gal. (3-4 Sq. Yd.)

CERAMIC TILE MEDIUM TO LARGE FORMAT



1/4" x 3/8" x 1/4" SQ **20007**
 Thin-Set Mortar
 60-65 Sq. Ft./50# Bag

VINYL & RUBBER STAIR TREADS RUBBER RADIAL TILE



1/16" x 1/16" x 3/32" U **20023**
 Non-Porous Subfloor
 170-200 Sq. Ft./Gal. (19-22 Sq. Yd.)

1/16" x 1/16" x 1/16" SQ **20005**
 Porous Subfloor
 140-170 Sq. Ft./Gal. (15-19 Sq. Yd.)

CERAMIC TILE LARGE FORMAT & IRREGULAR BACK

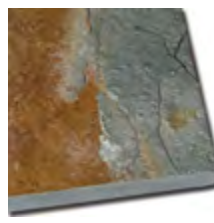

1/2" x 1/2" x 1/2" SQ **20008**
 Thin-Set Mortar
 25-35 Sq. Ft./50# Bag

CERAMIC TILE MOSAIC & SMALL FORMAT WALL



1/4" x 3/16" V **20010**
 Mastic
 50-55 Sq. Ft./Gal. (5-6 Sq. Yd.)

1/4" x 1/4" x 1/4" SQ **20006**
 Thin-Set Mortar
 70-90 Sq. Ft./50# Bag

CRACK ISOLATION MAT

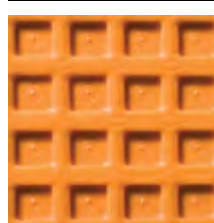

1/4" x 3/16" V **20010**
 Thin-Set Mortar
 150-200 Sq. Ft./50# Bag



POWERHOLD

TM

